

Introduction to the BMW K100 and 75 models.

After nearly sixty years of producing flat twin engined machines of very high quality but basically simple specification, BMW gave the motorcycling world something of a shock when the K100 was first announced late in 1983.



The K100 model 1983

At first glance it seemed the complete opposite of all those qualities that the company had previously found so important in a motorcycle, but on closer inspection it becomes obvious that great efforts have been made to make the machines as light, simple, and compact as possible and yet attractive to the modern motorcyclist. The design is intended to provide a sound basis for a long-running production, taking into account all current and pending noise and emission control legislation.

Research started in the mid-1970's into a replacement for the flat twin engines, which are already approaching the limits of reasonable development. A breakthrough came in 1979 with the patenting of the basic idea of taking a car engine, laying it on its side and transmitting the drive through a secondary output shaft. This provides a low center of gravity and a very distinctive appearance, as well as the basis for a short compact engine/transmission unit. The transmission is very similar in layout to that used on the twins but is totally redesigned, using lightweight materials wherever possible, with emphasis on keeping it as short and as compact as possible. The tubular spine type frame is bolted to the unit and carries a pair of conventional telescopic forks to provide steering and front suspension.



The K100RS model 1983

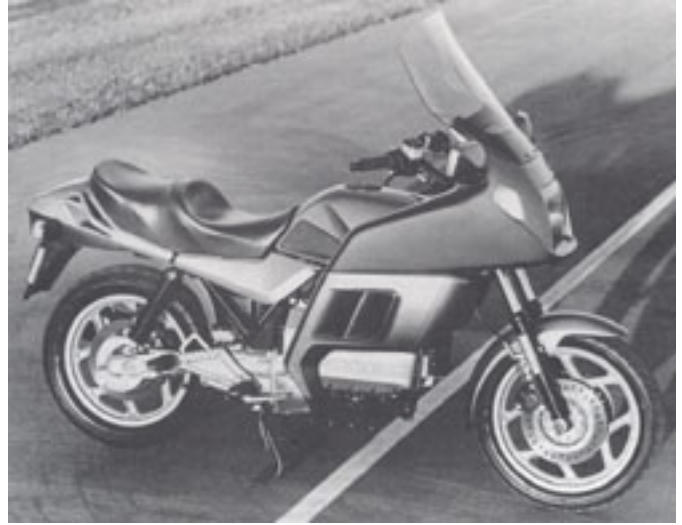

The K100RT model 1984

After the introduction of the K100 and K100RS in late 1983, followed by the K100RT in 1984 the machines suffered one or two teething troubles, as is inevitable with any brand-new design, which were soon rectified by the introduction of modified components. In addition to this, one or two modifications have been made to cure problems, which became evident in service; notably to reduce vibration and the build-up of heat under the fuel tank.

When the 750cc models were introduced, starting with the K75C in late 1985, the opportunity was taken to modify many 100-model components to take advantage of commonality of parts; BMW claim approximately 70% of the components are common to both models. The development of the smaller machines proceeded alongside the 100 models but introduction was delayed until 1985/86; as a result the 75-models incorporate all the lessons learned from the earlier 100-models.



The K75C model 1985



The K100LT Tourer

In common with their policy in previous years, BMW introduced various forms- of each basic model to cater for as many tastes as possible. Thus the basic K100 was followed by the sports/touring K100 RS, the touring K100RT and the fully-equipped K100LT tourer. The first 75-model was the K75C, which was followed by the more sports-orientated K75S and then the basic K75.

In all cases (except for final drive ratios, the sports suspension on the K75S and the rear wheel and brake on the K75 and K75C) the basic machine is exactly the same. Note: To avoid confusion with the basic K75 and K100 models, machines are referred to throughout the manual as '75' models or '100' models, except where a more precise definition is required.

Chapter 1: Engine

Specifications

Engine

Bore	67 mm (2.64 in)		
Stroke	70 mm (2.76 in)		
	75 models	100 models	
Number of cylinders	3	4	
Capacity	740 cc (45 cu in)	987 cc (60 cu in)	
	UK 75, early US 75 models*	Late US 75 models*	100 models
compression ratio	11,0 : 1	10,5 : 1	10,2 : 1
Maximum power - DIN (kw/bhp @ rpm)	55/75 @ 8500	51/70 @ 8200	66/90 @ 8000
Maximum torque - DIN (Nm/lbf ft @ rpm)	68/50 @ 6750	65/48 @ 6500	86/63 @ 6000
* <i>Changeover date approximately mid - 1986</i>			
Cylinder identification	Numbered consecutively front to rear. Number 1 cylinder at front (cam chain) end.		
Firing order			
75 models	3 - 1 - 2		
100 models	1 - 3 - 4 - 2		
Direction of rotation	Anticlockwise, looking at ignition trigger from front of machine.		

Compression pressure - see Section 2

Good	Over 10,0 bar (145 psi)
Normal	8,5 - 10,0 bar (123 - 145 psi)
Poor	Below 8,5 bar (123 psi)

Valve timing - at 5/100 preload and 3 mm (0.12 in) lift

	UK models	US models
Intake opens	5° BTDC	5° ATDC
Intake closes	27° ABDC	27° ABDC
Exhaust opens	28° BBDC	28° BBDC
Exhaust closes	5° BTDC	5° BTDC

Valves clearances - engines cold (max. coolant temperature 20°C / 68°F)

Intake	0,15 - 0,20 mm (0.006 - 0.008 in)
Exhaust	0,25 - 0,30 mm (0.010 - 0.012 in)

Camshafts and cam followers

Camshaft bearing journal OD:

At front (thrust) bearing	29,980 - 29,993 mm (1.1803 - 1.1808 in)
At all other bearing	23,980 - 23,993 mm (0.9441 - 0.9446 in)

Cylinder head bearing ID:

At front (thrust) bearing	30,020 - 30,041 mm (1.1819 - 1.1827 in)
At all other bearing	24,020 - 24,041 mm (0.9457 - 0.9465 in)

Camshaft radial clearance 0,027 - 0,061 mm (0.0011 - 0.0024 in)

Camshaft base circle 30,000 mm (1.1811 in)

Cam lift:

Intake	9,3927 mm (0.3698 in)
Exhaust	9,3819 mm (0.3694 in)

Cam follower OD 33,475 - 33,491 mm (1.3179 - 1.3185 in)

Cylinder head bore ID 33,500 - 33,525 mm (1.3189 - 1.3199 in)

Cam follower/cylinder head clearance 0,009 - 0,050 mm (0.0004 - 0.0020 in)

Valves, guides and springs

Valve head diameter:

Intake	34 mm (1.3386 in)
Exhaust	30 mm (1.1811 in)

Valve head rim thickness:

Standard	1,350 - 1,650 mm (0.0532 - 0.0650 in)
----------	---------------------------------------

Service limit	1,000 mm (0.0394 in)
Valve head maximum runout	0,030 mm (0.0012 in)
Valve overall length:	
Intake	111,000 mm (4.3701 in)
Exhaust	110,610 - 110,810 mm (4.3547 - 4.3626 in)
Valve stem OD:	
Intake	6,960 - 6,975 mm (0.2740 - 0.2746 in)
Exhaust	6,945 - 6,960 mm (0.2734 - 0.2740 in)
Valve guide ID:	7,000 - 7,015 mm (0.2756 - 0.2762 in)
Valve stem/guide clearance:	
Intake - standard	0,025 - 0,055 mm (0.0010 - 0.0022 in)
Exhaust - standard	0,040 - 0,070 mm (0.0016 - 0.0028 in)
Intake & Exhaust service limit	0,150 mm (0.0059 in)
Valve guide overall length	45,0 mm (1.7717 in)
Valve guide OD	12,964 - 13,044 mm (0.5104 - 0.5135 in)
Cylinder head bore ID	13,000 - 13,018 mm (0.5118 - 0.5125 in)
Valve guide oversize available	+ 0,2 mm (+ 0.0079 in)
Valve seat angle	44° 10' - 44° 30'
Valve seat width	1,5 mm (0.0591 in)
Valve seat oversize available	+ 0,2 mm (+ 0.0079 in)
Valve spring standard free length	44,500 mm (1.7520 in)
Spring force at 29 mm (1.14 in) test length	740 - 800 N (166.36 - 179.85 lbf)

Cylinder block

Bore ID	66,995 - 67,005 mm (2.6376 - 2.6380 in)
Piston/cylinder clearance	
Standard	0,030 - 0,040 mm (0.00012 - 0.00016 in)
Service limit	0,080 mm (0.0032 in)

Chapter 1: Engine

1. General description

The engine is a liquid cooled four-stroke type, of three cylinders (75 models) or four cylinders (100 models). The cylinders are arranged inline but the crankshaft is disposed longitudinally, parallel to the machine's center line and the cylinders are laid flat so that the cylinder head (or 'top' end) is on the machine's left and the crankshaft (or 'bottom' end) is on its right. All castings are of aluminum alloy, the main crankcase being made as light and compact as possible by the use of plated cylinder bores instead of separate (usually cast iron) liners. The pistons run in bores which are accurately machined in the crankcase and given a hard bearing surface by having a thin layer of nickel/silicon carbide ('Scanimet') deposited electrically and ground to the required tolerances. Passages for coolant are included in the cylinder head and block castings. The forged steel crankshaft incorporates four (75 models) or five (100 models) plain main bearing journals which rotate in split shell bearings and are secured to the crankcase by large bolted-on caps. The rearmost crankshaft web is fully circular with gear teeth machined in its periphery, and a small sprocket and rotor flange are attached to the crankshaft front end to drive respectively the camshaft and ignition trigger assembly. The connecting rods have detachable bolted on big-end caps; split shell bearings are fitted at the big-end bearing and a plain bush at the small-end bearing. The pistons are flat-topped and are fitted with two plain compression rings and one oil scraper ring. The valves are set in deep wells in the cylinder head and are each closed by a single coil spring. An inverted bucket-type cam follower (or tappet) is fitted over each valve spring assembly; these cam followers have a recess machined in their upper ends into which a thick steel shim is placed to permit adjustment of the valve clearances. The shims are hardened to withstand the action of the camshaft lobes which bear directly upon them. The valve opening is controlled by two overhead camshafts which run in bearing surfaces machined directly in the cylinder head casting and are each retained by four (75 models) or five (100 models) separate bearing caps. They are driven from the crankshaft by a single-row roller chain which has plastic-faced guide blades between the camshafts and between the intake camshaft and the crankshaft, and a plastic-faced pivoting tensioner blade which is pressed against the chain 'slack' run (i.e. between the crankshaft and the exhaust

camshaft) by a hydraulically-operated chain tensioner assembly. Drive from the crankshaft is transmitted via the large gear on the rear web to a secondary shaft which is disposed parallel to and underneath the crankshaft along the machine's ' center line. The matching gear on this secondary, or engine output, shaft is of the same size as the crankshaft gear to give a 1:1 reduction ratio but incorporates a spring-loaded anti-backlash gear to reduce noise. The shaft serves not only to transmit drive to the clutch and transmission but also drives the combined oil/water pump assembly

from its forward end. On 75 models two balancer weights are incorporated in the shaft to cancel out the rocking couple produced by the motion of the two outer pistons and thus eliminate the only vibration source inherent in any 120° triple; on 100 models drive is actually transmitted via a large housing, with vanes protruding from its inner surface, through rubber blocks to damp out transmission shocks to a vaned shock absorber inner which is splined to the output shaft. The shaft rotates in a needle roller bearing at its forward end and a ball journal bearing at its rear end, both bearings being clamped to the underside of the main crankcase/cylinder block casting by the crankcase lower section, which also acts as the engine oil reservoir.

The fourth major engine casting is the bellhousing which is attached to the rear end of the crankcase and houses the clutch and alternator/starter motor drive components. An auxiliary drive shaft is driven via a 1,5 : 1 reduction ratio from the crankshaft gear, rotates in a needle bearing in the crankcase and a ball journal bearing set in the top of the bellhousing and has the drive flange of the alternator shock absorber bolted to its rear end. The electric starter motor drives via an idler shaft set in the bellhousing through a starter clutch mounted on the auxiliary drive shaft; a total reduction ratio of 27 : 1. Early UK only K100 and K100 RS models were fitted with a clutch containing three rollers looked by spring-loaded plungers, while later models are fitted with a sprag-type clutch containing fourteen locking elements.

Since the output/balancer shaft and the auxiliary drive shaft are gear-driven from the crankshaft they rotate in the opposite direction to it. Their combined mass, with that of the alternator and clutch, cancels out the lateral torque reaction which would otherwise be evident from the crankshaft of an engine of this layout.

Specifications

models.

Spark plugs	Bosch XSDC
Spark plug gap:	
Standard	0.6 - 0.7 mm (0.024 - 0.028 in)
Service limit	0.8 mm (0.032 in)
Valve clearances - engine cold (maximum coolant temperature 20 °C/68 °F):	
Intake	0.15 - 0.20 mm (0.006 - 0.008 in)
Exhaust	0.25 - 0.30 mm (0.010 - 0.012 in)
Idle speed	950 ± 50 rpm
Throttle and 'choke' cable free play	0.5 - 1.0 mm (0.02 - 0.04 in)
Clutch cable free play - at handlebar lever:	
75 models	2.0 - 2.5 mm (0.08 - 0.10 in)
100 models	4.0 - 4.5 mm (0.16 - 0.18 in)
Length of clutch inner cable at gearbox end	75 + 1 mm (2.95 + 0.04 in)

Cycle parts		
Brake pad/shoe friction material minimum thickness	1.5 mm (0.06 in)	
Drum rear brake free play - at pedal tip	15 - 25 mm (0.6 - 1.0 in)	
Tire pressures - tires cold:	Front	Rear
75 models:		
Solo	29 psi (2.00 bar)	36 psi (2.50 bar)
Pillion	34 psi (2.30 bar)	42 psi (2.90 bar)
100 models:		
Solo	33 psi (2.25 bar)	36 psi (2.50 bar)
Pillion up to 112 mph (180 km/h)	33 psi (2.25 bar)	39 psi (2.70 bar)
Pillion above 112 mph (180 km/h)	39 psi (2.70 bar)	42 psi (2.90 bar)

Recommended lubricants	
Engine:	
Capacity - at oil and filter change	3.75 lit (6.6 Imp pint, 3.9 US qt)
Recommended oil	Good quality HD oil suitable for 4-stroke spark ignition engines. API classification SE or SF
Viscosity	See chart in Routine Maintenance
Gearbox and final drive case:	
Capacity:	
Gearbox	850 + 50 cc (1.50 + 0.09 Imp pint, 0.90 + 0.05 US qt)
Final drive case	260 cc (0.46 Imp pint, 0.28 US qt)
Recommended oil	Good quality hypoid gear oil of API class GL-5 or to specification Mil-L-2105 B or C
Viscosity:	
Above 5 °C (41° F)	SEA 90 Below 5 °C (41°F)
SEA 90 Below 5 °C (41°F)	SEA 80
Alternatively	SAE 80W90
Coolant	
Fuel	

Front forks:	280 ± 10 cc (9.86 ± 0.35 Imp fl oz, 9.47 ± 0.34 US fl oz)
Capacity - per leg:	
KI00, all other 75 models	330 ± 10 cc (11.62 ± 0.35 Imp fl oz, 11.16 ± 0.34 US fl oz)
KI00 R S, KI00RT, KI00 LT	360 ± 10 cc (12.67 ± 0.35 Imp fl oz, 12.17 ± 0.34 US fl oz)
Recommended oil	Use specified brands and types only see 7
Brake fluid	DOT 4, eg ATE 'SL'
Splined couplings and joints, ie clutch plate, gearbox input shaft, final drive shaft	Staburags NBU 30 PTM compound, Optimol Paste PL or Uni Moly C 220 Slip Agent
Front wheel, steering head and swinging arm pivot bearings	Good quality high melting-point lithium fiber-based grease, eg Shell Retinax A
Fluidbloc steering head damper	Silicone grease only eg 'Silicone Grease 300 Heavy'
All other greasing points	As wheel bearings type
Battery terminals	Petroleum jelly (Vaseline) or acid-free grease eg Bosch Ft 40 V1
Control cable nipples and all other pivots	Engine oil or light machine oil
Control cables	Nylon lined - if lubrication is considered necessary use only suitable lubricant

Recommended lubricants	
Engine:	
Capacity - at oil and filter change	3.75 lit (6.6 Imp pint, 3.9 US qt)
Recommended oil	Good quality HD oil suitable for 4-stroke spark ignition engines. API classification SE or SF
Viscosity	See chart in Routine Maintenance
Gearbox and final drive case:	
Capacity:	
Gearbox	850 + 50 cc (1.50 + 0.09 Imp pint, 0.90 + 0.05 US qt)
Final drive case	260 cc (0.46 Imp pint, 0.28 US qt)
Recommended oil	Good quality hypoid gear oil of API class GL-5 or to specification Mil-L-2105 B or C
Viscosity:	
Above 5 °C (41° F)	SEA 90 Below 5 °C (41°F)
SEA 90 Below 5 °C (41°F)	SEA 80
Alternatively	SAE 80W90
Coolant	
Fuel	

Check tires	X	X	X
Check and lubricate wheel bearings			X
Check brake system for leakage	X		X
Check brake fluid level (front and rear). Change brake fluid every two years !	X		X
Check brake system (front and rear)			X
Check and adjust ABS impulse transmitter clearance (front and rear)		X	X
Check and clean ABS impulse wheel		X	X
Check function of electrical side stand switch (angle)		X	X
Check and adjust bearings of steering head, swinging arm pivot and paralever			X
Check tightness of nuts and bolts	X	X	X
Check battery fill level			X
Renew the plastic-faced guide blades of the camshaft chain every 60,000 km			

The final inspection of every maintenance includes the check of tires and wheels, tire pressure, signals, check lights, clutch, gear-shift, brakes, ABS, steering, dashboard and a density control of the front fork.

Periodic maintenance as published at BMW's service guide 1.91,
Item no. 01 70 9 789 890.

Introduction

Periodic routine maintenance is a continuous process, which should commence immediately the machine, is used. The object is to maintain all adjustments and to diagnose and rectify minor defects before they develop into more extensive, and often more expensive, problems.

It follows that if the machine is maintained properly, it will both run and perform with maximum efficiency, and be less prone to unexpected breakdowns. Regular inspection of the machine will show up any parts which are wearing, and with a little experience, it is possible to obtain the maximum life from any one component, renewing it when it becomes so worn that it is liable to fail.

Regular cleaning can be considered as important as mechanical maintenance. This will ensure that all the cycle parts are inspected regularly and are kept free from accumulations of road dirt and grime.

All intervals are intended as a guide only; as a machine gets older it develops individual faults that require more frequent attention and if used under particularly arduous conditions it is advisable to reduce the period between each check.

For ease of reference, most service operations are described in detail under the relevant heading. However, if further general information is required, this can be found under the pertinent Section heading and Chapter in the main text.

While some special tools are required for routine maintenance, a good selection of general workshop tools is essential. Included in the tools must be a range of metric ring or combination spanners and a selection of good quality Allen keys; all necessary tools being included in the machine's toolkit.

Service intervals - mileage:

BMW maintenance is grouped into two parts, a minor and a major service, which must be carried out at the following intervals:

Minor service every 10000 miles (15000 km) starting with the first 5000 miles (7500 km)

Major service every 10000 miles (15000 km) starting with the first 10000 miles (15000 km)

Therefore minor and major services should be carried out alternately at every 5000 miles (7500 km)

Service intervals - time:

If the machine is not used regularly, or does not cover a high mileage, BMW recommend that a major service be carried out each year to preserve the machine's performance and reliability. Therefore, the minor service should be carried out every six months, the major service annually.

Additional recommendations:

- Engine oil - in normal use the engine oil should be changed every six months at the latest. If the engine is used in temperatures below 0 C (32°F), or for short, local journeys only, the oil should be changed every 2000 miles (3000 km) or three months at the latest.
- Gearbox oil - must be changed at least once annually.
- Final drive case oil - must be changed at least once annually.
- Front fork oil - must be changed at least once annually.
- Hydraulic brake fluid - must be changed annually.
- Coolant - must be changed every two years at least.
- Fuel filter - must be renewed every 20 000 miles (30 000 km) in normal use, ie every second major service, but if the filter is dirty or of poor quality it must be renewed at every major service.
- Wheel and steering head bearings - if conditions are very severe these bearings

and the twist grip must be cleaned and packed with new grease every 20 000 miles (30 000 km).

- Battery - should be checked at least every three months.
- Air filter - should be cleaned and renewed at more frequent intervals if the machine is used in very dusty or severe conditions.

Cleaning the machine

Regular cleaning can be considered as important as mechanical maintenance. This will ensure that all the cycle parts are inspected regularly and are kept free from accumulations of road dirt and grime.

Cleaning is especially important during the winter months despite its appearance of being a thankless task, which very soon seems pointless. On the contrary, it is at this time that the paintwork, chromium plating, and the alloy casings suffer the ravages of abrasive grit, rain and road salt. A couple of hours spent weekly on cleaning the machine will maintain its appearance and value, and highlight small points, like chipped paint, before they become a serious problem.

Use a sponge and copious amounts of warm soapy water to wash surface dirt from these components. Remove oil and grease with a solvent such as 'Gunk' or 'Jizer', working it in with a stiff brush when the component is still dry and rinsing it off with fresh water. Be very careful to keep water away from the air intake, the brakes, wheel bearings, steering head and swinging arm pivot bearings, gearbox and final drive case breathers and all electrical components; never direct the jet from a hose or similar directly on to any of these vulnerable components. When the wash is finished, lean the machine on its side stand and shake it lightly until any water gathered on top of the crankcase has escaped through the drain channel provided; this is to avoid the cloud of steam that will be generated if engine heat is used to dry out the machine. If moisture is concentrated around the electrical components in this way, electrical faults through short circuits and corrosion will soon follow; BMW recommend that all electrical connectors are unplugged and coated at least once a year with a water dispersant lubricant or corrosion inhibitor such as WD40 or CRC5-56.

Apply wax polish to the painted components and those, which are chromed. Keep the control cables well sealed to prevent the ingress of water and wipe the machine down if used in the wet.

Do not use strong detergents, scouring powders or any abrasive when cleaning plastic components; anything but a mild solution of soapy water may well bleach or score the

surface. On completion of cleaning, wipe the component dry with a chamois leather. If the surface finish has faded, use a fine aerosol polish to restore its shine.

Note: while it is realized that cleaning a machine is quickest and most effective if carried out using a pressure washer, steam cleaner or even a very powerful hose, the very real disadvantages of such usage should be pointed out. Quite apart from the rapid deterioration of the finish of plastic components caused by the scouring action of caked-on dirt being blasted off, the operating pressure of such machines is high enough to force a mixture of dirt and water past oil seals, etc. and into the bearings, brakes, forks and suspension unit, causing their premature failure unless great care is taken to dismantle, clean and lubricate all cycle parts after cleaning. If cleaning must be carried out in this way, be very careful both when cleaning and afterwards; check also that the jet is also directed away from the fuel tank filler cap, the gearbox and final drive case breathers and from the handlebar switches and other electrical components

Daily (pre-ride) check

It is recommended that the following items are checked whenever the machine is about to be used. This is important to prevent the risk of unexpected failure of any component while riding the machine and with experience, can be reduced to a simple checklist which will only take a few moments to complete. For those owners who are not inclined to check all items with such frequency, it is suggested that the best course is to carry out the checks in the form of a service, which can be undertaken each week, or before any long journey. It is essential that all items are checked and serviced with reasonable frequency.

1. Check the tires

Check the tire pressures with a gauge that is known to be accurate. It is worthwhile purchasing a pocket gauge for this purpose because the gauges on garage forecourt airlines are notoriously inaccurate. The pressures, which should be checked with the tires cold.

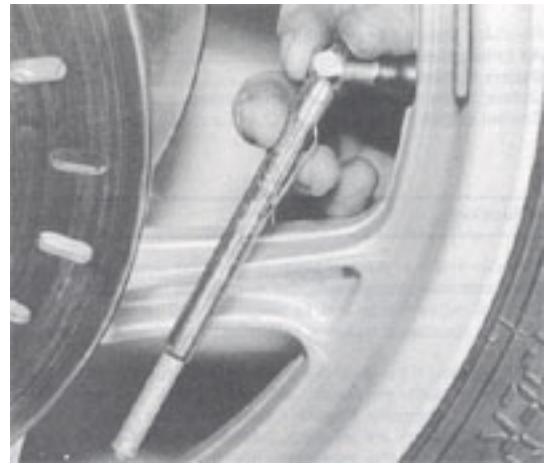

Use only an accurate gauge to check tire pressures

If the machine is fitted subsequently with another make and/or type of tire, the owner must check with the tire manufacturer to find out if different pressures are necessary. In most cases the BMW importer will be able to help with advice on recommended tires and pressures. Finally, ensure at all times that the pressures are suited to the load the machine is carrying and the speed at which it will be traveling.

At the same time as the tire pressures are checked, examine the tires themselves. Check them for damage, especially splitting of the sidewalls. Remove any small stones or other road debris caught between the treads. When checking the tires for damage, they should be examined for tread depth in view of both the legal and safety aspects.

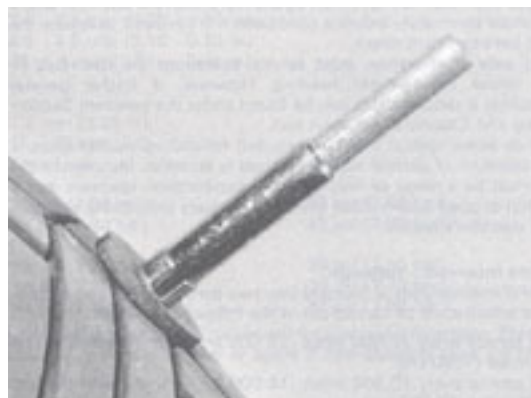

Tread depths are measured at center of tread

It is vital to keep the tread depth within the UK legal limits of 1mm of depth over three-quarters of the tread breadth around the entire circumference with no bald patches. Many riders, however, consider nearer 2 mm to be the limit for secure road holding, traction, and braking, especially in adverse weather conditions, and it should be noted that BMW recommend minimum tread depths of 2.0 mm (0.08in) for speeds below 80 mph (130 km/h), or 3 mm (0.12 in) for speeds above 80 mph (130 km/h), measured at the center of the tread.

If new tires are to be fitted, they must be of the correct size and speed or load rating, as listed in the Specifications Section of Chapter 9.. However great care must be taken when choosing new tires. First check with the importer or a good local BMW dealer what types of currently-available tire are approved for use on your particular model; do not forget to check the recommended tire pressures, if different. Do not use any other tire than those that are approved; if a particular make and/or type is not approved the factory, which conducts exhaustive tests, will have a very good reason for this. Once you have made your choice from the available selection, always fit front and rear tires from the same manufacturer; never mix different tire brands. Finally note the new pressures (if different) at all loads and speeds and keep this with the machine.

2. Check the engine oil level

The engine must have been stopped for a few minutes so that the level settles before it can be checked accurately. If the engine is cold, warm it up to normal operating temperature, then switch off and wait before checking the level. With the machine on its center stand, on level ground, check the oil level as seen in the sight glass set in the right-hand side of the crankcase lower section. The maximum and minimum level marks are indicated by imaginary horizontal lines drawn through the top and bottom of the circle marked on the glass; the oil level should be maintained between these marks; ie somewhere in the circle, at all times. Never run the engine with the level below the circle or above it; both conditions can lead to engine damage.

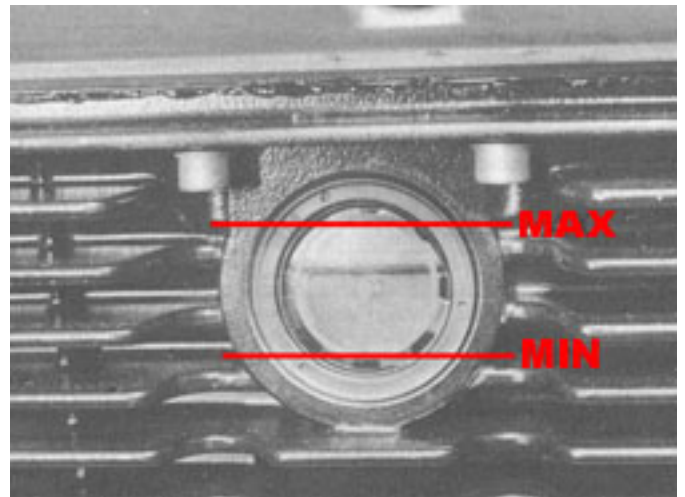

Engine oil level must be maintained between maximum and minimum level lines

If topping-up is required, remove the filter plug from the rear and of the engine right-hand outer (crankshaft) cover and add the required amount of oil; it will take approximately 0.6 liter (1.06 Imp pint, 0.63US qt) to fill the crankcase from minimum to maximum. Use only a good quality, heavy-duty oil suitable for 4-stroke spark ignition engines. Refer to the accompanying thermometer chart to decide what viscosity of oil is necessary at the prevailing outside temperatures. BMW recommend that a medium range multigrade, eg 10W30 is preferable to a wide range multigrade, such as 10W50, and that multigrades are preferable to monogrades.

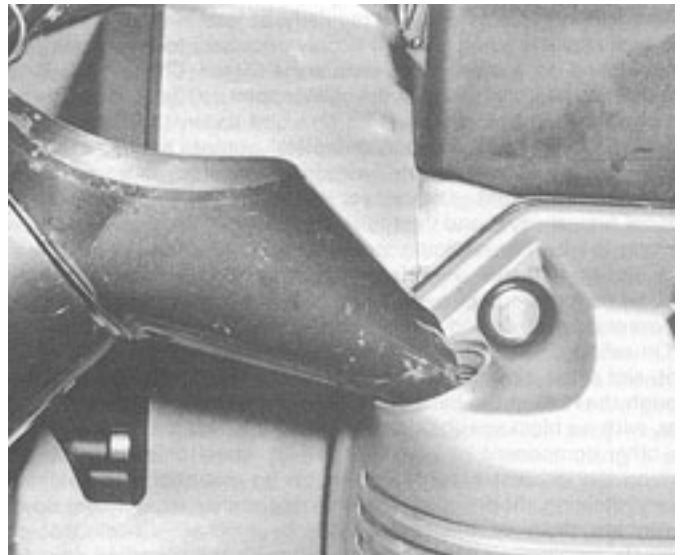

Use only good quality engine oil specified type when topping up

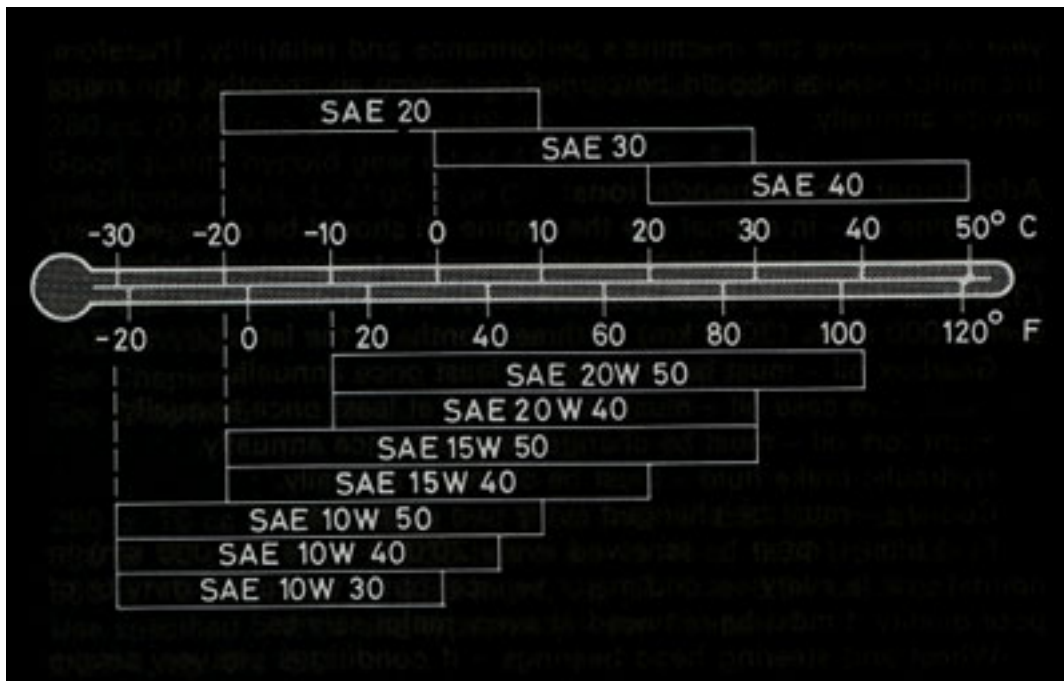

Engine oil viscosity selection chart

Note: In normal use the sight glass will be self-cleaning, but if the machine is used only in cold weather, or infrequently, or for very short journeys only, the glass will become obscured by deposits of emulsified sludge. The only way to avoid this is to take the machine regularly on a journey of sufficient length to warm it up thoroughly; this will evaporate the moisture from the oil and should clean the glass.

If this not possible, the engine oil must be changed at more frequent intervals (see additional recommendations) to keep it and the engine clean; note that the starter clutch may slip on early models if the sludge deposits are allowed to build up too much.

3. Check the fuel level

Checking the petrol level may seem obvious, but it is all too easy to forget. Ensure that you have enough petrol to complete your journey, or at least to get you to the nearest petrol station. Be very careful not to allow dirt or water into the tank, particularly when opening the filler cap, and never fill the tank to the brim; always leave a space at the top to allow for fuel expansion under engine heat. Owners of US models should note that the flap beneath the filler cap is fitted to prevent the tank from being overfilled; the flap must never be removed or modified. See Chapter 5.

Note carefully the recommendations given in Chapter 5 concerning types and grades of fuel, and never use additives of any sort.

4. Check the coolant level

Since the coolant level varies with engine temperature, it must be checked only when the machine is cold. The expansion tank situated beneath the right-hand side panel has a level tube of clear plastic mounted on its front end with 'Maximum' and 'Minimum' level marks on the tank itself. If the level of coolant in the tube is below the minimum level mark, the tank should be topped up to the maximum mark by removing the filler cap and adding the specified type of coolant. See Chapter 4.

If the coolant requires repeated topping-up, the reason for the loss should be investigated as described in Chapter 4; only very small losses should occur in normal use. If the level tube is so discolored that the coolant level can not be seen, it should be renewed and the system should be refilled using the specified, nitride-free, antifreeze.

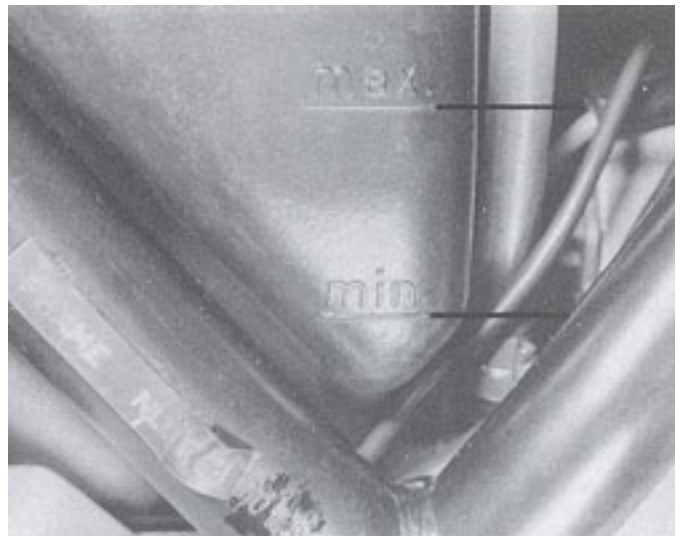

Coolant level must maintained between expansion tank level lines check only when engine is cold

5. Legal check

Check that all lights, turn signals horn and speedometer are working correctly to make sure that the machine complies with all legal requirements in this respect. Check also that the headlamp is correctly aimed. See chapter 10.

6. Check the brakes

Check that the front and rear brakes work effectively and without binding.

7. Check the controls

Check the throttle and clutch cables and levers and the gear lever to ensure that they are adjusted correctly, and that they are securely fastened. If a bolt is going to work loose, or a cable snap, it is better that it is discovered at this stage with the machine at a standstill, rather than when it is being ridden.

8. Rear suspension settings

Except for machines with Nivomat rear suspension, ensure that the spring preload adjuster is at the correct setting for the machine's intended load.

9. Check the tightness of all nuts and bolts

Using the specified torque wrench settings (where given), check that all fasteners are tightened securely, particularly the wheel spindle retainer and clamp bolts, the rear wheel mounting bolts and the stand, footrest and suspension unit mounting bolts or nuts.

10. Check the battery

The battery must be checked regularly, at least every three months. If a quick check is being made, it is only necessary to unlock and raise the seat and to remove both side panels (see Chapter 7). If the terminals are being checked or the cells topped up the storage tray and fuel injection control unit must be removed as well, as described in

Chapter 5 To remove the battery completely, unlock and raise the seat, remove both side panels and withdraw the storage tray and fuel injection control unit. Disconnect the battery terminals (negative terminal first, always) and vent tube, then remove the two long screws securing the battery retaining strap to the battery tray. Withdraw the strap, noting that this will release the coolant expansion tank which must be secured out of harm's way. Tilt the battery backwards and withdraw it upwards and to the rear.

On refitting, insert the battery carefully, with its terminals to the front, and settle it on the rubber pads on the tray. Route the vent tube through the hole at the base of the rear mudguard and check that it is clear, with no blockages or kinks, and that it hangs down well clear of any other component particularly the rear wheel or exhaust system. Position the coolant expansion tank on its mountings and refit the battery retaining strap; tighten the retaining screws securely but do not over tighten them or the battery will be cracked. Check that the terminals are scraped clean and coated with the specified acid-free grease to prevent corrosion, then reconnect the positive (+ve) terminal first, followed by the negative (-ve). Tighten the terminal nuts and bolts securely and refit their covers.

To check the electrolyte level, position the machine so that the battery is level. Where level marks are provided on the battery casing ensure that the electrolyte level is between the marks; if not the level in each cell must be between 5 - 10 mm (0.2 - 0.4 in) below the black plastic top. If topping-up is necessary, remove the battery retaining strap and use a coin or similar to unscrew each cell cover plug. Use only distilled water to top up to the maximum level mark, then refit the cell cover plugs and retaining strap.

Check that the vent tube is clear and that it has no kinks or blockages, also that it hangs

well clear of any other component (see above). If the terminals are loose or corroded disconnect them (negative terminal first, always) and scrape them clean. On refitting, apply a coat of petroleum jelly or acid-free grease to each to prevent corrosion and tighten the retaining nuts and bolts securely.

Always check that the terminals are tight and that the covers are correctly refitted, also that the fuse connections are clean and tight, that the fuses are of the correct rating and in good condition, and that spares are available on the machine should the need arise.

At regular intervals remove the battery and check that there is no pale gray sediment deposited at the bottom of the casing. This is caused by sulphation of the plates as a result of re-charging at too high a rate or as a result of the battery being left discharged for long periods.

A good battery should have little or no sediment visible and its plates should be straight and pale gray or brown in color. If sediment deposits are deep enough to reach the bottom of the plates, or if the plates are buckled and have whitish deposits on them, the battery is faulty and must be renewed. Remember that a poor battery will give rise to a large number of minor electrical faults.

If the machine is not in regular use, disconnect the battery and give it a refresher charge every month to six weeks, as described in Chapter 10

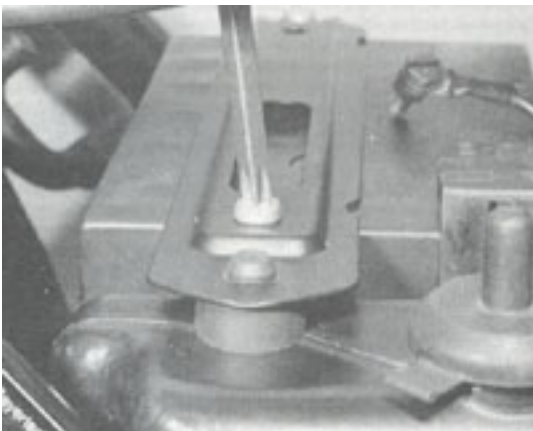

Battery (and coolant expansion tank) is retained by a single strap - unscrew securing screws to release

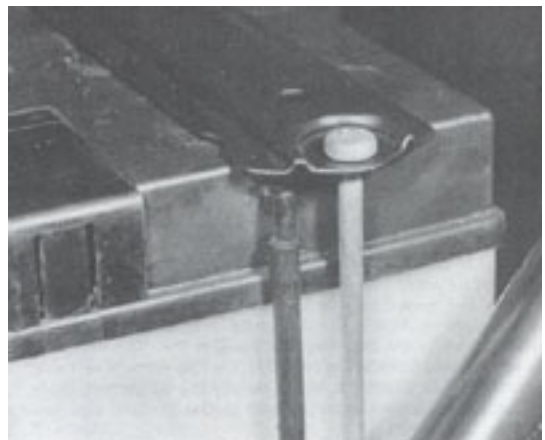

Ensure vent tube is free from blockages or kinks on refitting

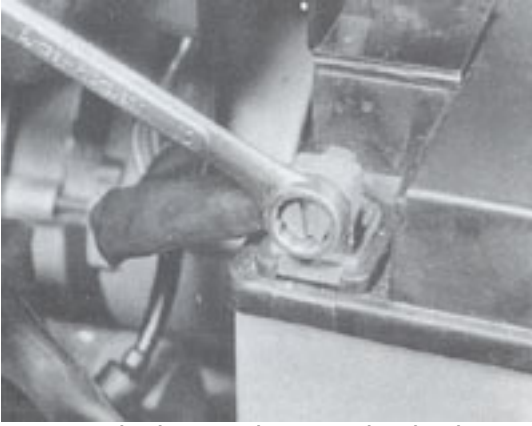

Battery terminals must be completely clean and securely fastened at all times

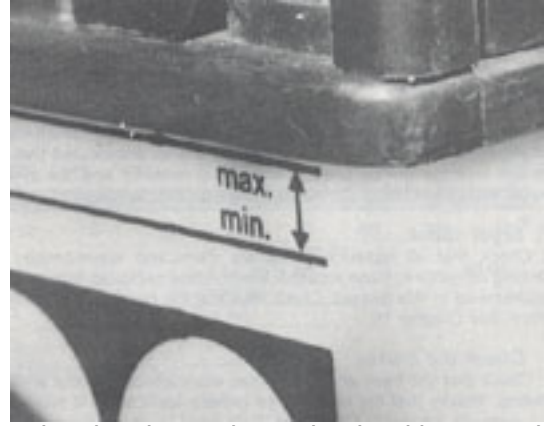

Electrolyte level must be maintained between level lines on battery casing

Next chapter: Minor service

1. Change the engine oil and filter

Oil changes will be much quicker if the machine is first ridden far enough to warm up the engine to normal operating temperature this will thin the oil and ensure that any particles of dirt or debris will be retained in suspension in the oil and flushed out with it.

Place the machine on its center stand on level ground, place container of at least 4 liters (approx 7 Imp pints, 4 US qts) beneath the crankcase. Unscrew the filler plug from the engine right-hand outer (crankshaft) cover, then use a suitable Allen key to unscrew the drain plug from the center of the sump (oil pan). While the oil is draining into the container, clean the drain plug carefully, wiping any metal particles off its magnetic insert, and renew its sealing washer if it is worn, flattened or damaged.

Remove the three retaining screws and withdraw the oil filter cover, noting the sealing O-ring. Wash the cover in a high flash-point solvent and renew the O-ring if it is worn or damaged.

Unscrew and discard the oil filter element. On very early 100 models the element had a hexagon form moulded into its lower end to permit fitting and removal, using a suitable spanner. However, it was over tightened by some owners to the point where the filter cracked or its seal failed under pressure, or even the crankcase lower section was cracked. The machining of the filter sealing surface was modified on later models to lessen the risk of this happening, and a modified filter element was introduced which has no hexagon and therefore requires a special tool, BMW part number 11 4 650 to fit and unscrew it. The tool is reasonably cheap and should be easily available from any authorized BMW dealer; in fact aftermarket versions of it are already available. If the tool is not available, the sump (oil pan) must be withdrawn (see Chapter 5) and the filter unscrewed using a strap wrench or similar car-type filter removal tool; if this is done the oil pump pick-up screen should be cleaned as described in Chapter 5. Note that none of the early type filters should now remain in service; all should have been replaced by the later modified type.

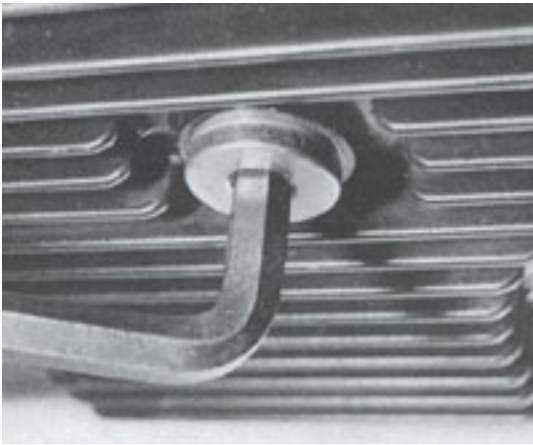

Unscrew drain plug from center of sump (oil pan) to drain engine oil

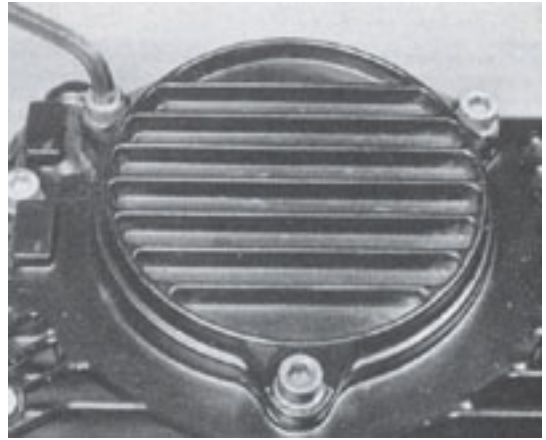

Engine oil filter is located inside separate cover bolted to sump (oil pan)

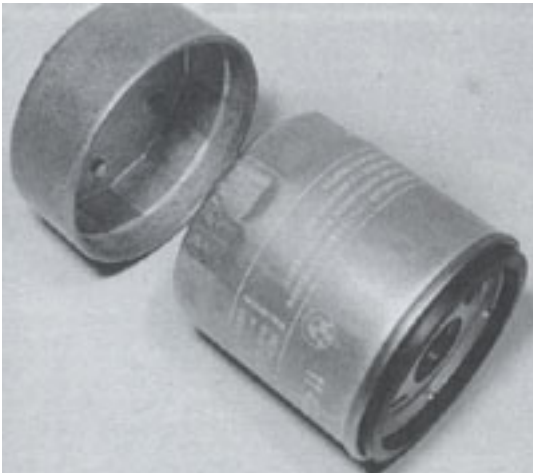

Oil filter element must be removed using a special tool which engages its shaped end...

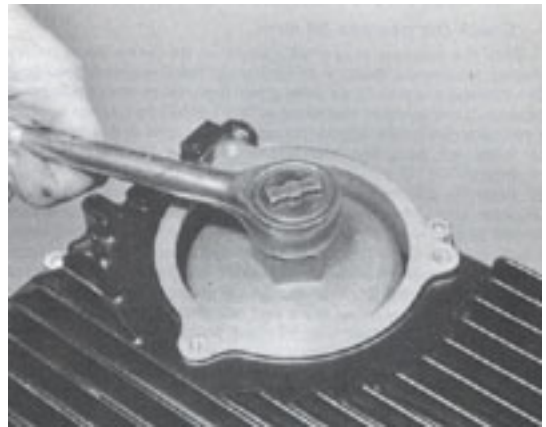

... and is unscrewed using a spanner or other tools as shown

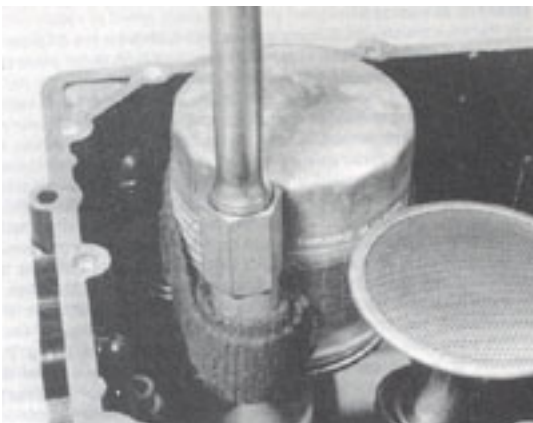

If special tool is not available car-type filter strap wrench can be used as shown after sump (oil pan) has been removed

When all the old oil has drained, thoroughly, clean the filter sealing surface and apply a film of oil to the new filter's sealing ring. Screw the new element into place by hand only until it seats lightly, then tighten it by a **maximum** of half a turn. If tools other than the BMW special tool (or a pattern version of it) are being used, be very careful not to over tighten the filter element or to damage its casing as it is installed. Refit the sump (oil pan) as described in Chapter 5, if applicable. Ensuring that the sealing O-ring is correctly installed, refit the filter cover and tighten the retaining screws securely; use the

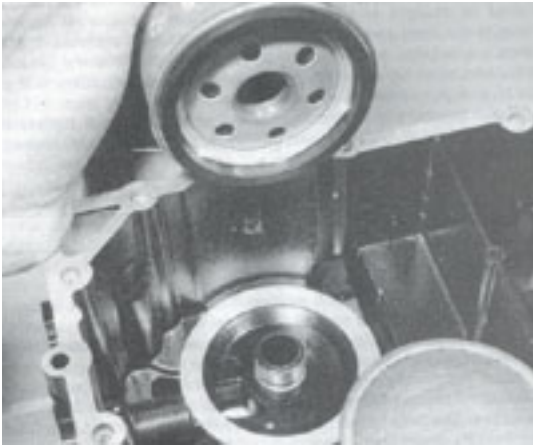

Fit filter element as described in text, being careful not to over tighten - note oil pump pick-up filter gauze, which must be cleaned whenever sump (oil pan) is removed

Fill the crankcase with the specified amount of the correct type and viscosity of engine oil, refit the filler plug, then start the engine and allow it to warm up to normal operating temperature to distribute the new oil fully around the engine. Stop the engine and wait a few minutes for the level to settle then check it and top up, if necessary, as described under the daily check heading. Wipe off any spilt oil, check that both filler and drain plugs (and other disturbed components) are securely and correctly refitted, and check subsequently for signs of oil leaks.

Note that whenever the sump (oil pan) is removed, the crankcase interior should be wiped clean with a lint-free cloth and the oil pump pick-up filter gauze should be cleaned. Refer to Chapter 5.

specified torque wrench setting, where available. Ensuring that its sealing washer is correctly installed and its threads are clean and dry, refit the engine oil drain plug and tighten it securely to its specified torque wrench setting.

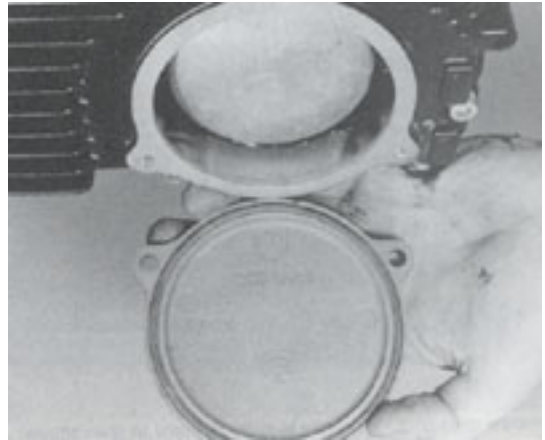

Check sealing O-ring is correctly installed when refitting filter element cover

2. Check the gearbox oil level

With the machine supported upright on its center stand on level ground, remove the gearbox oil filler plug. The C-spanner provided in the machine's toolkit is also designed to serve as a dipstick for the gearbox.

If the spanner, part number 71 11 2 300 061, is not available, it can be ordered from any authorized BMW dealer or a substitute can be fabricated from the dimensions shown in the accompanying illustration. Insert the spanner into the gearbox filter orifice until the spanner's shoulder rests on the machined filter plug seating surface. The oil level should be above the minimum mark formed by the spanner's bottom end, but below the maximum mark formed by the line etched across the spanner handle. Remove any surplus oil. If topping up is necessary use only good quality oil of the specified type. Renew the scaling washer if it is damaged or worn and refit the filler plug, tightening it securely, to the specified torque setting (where given). Wash off any spilt oil.

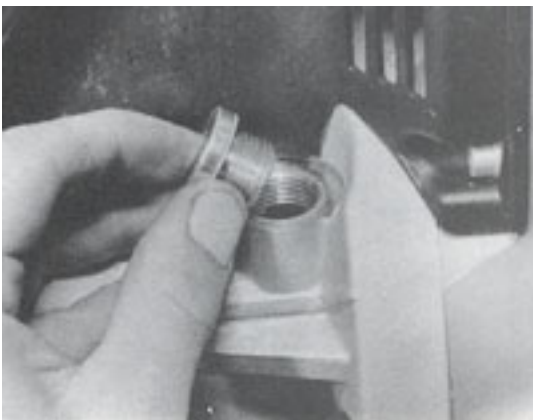

Remove gearbox filler plug to check oil level

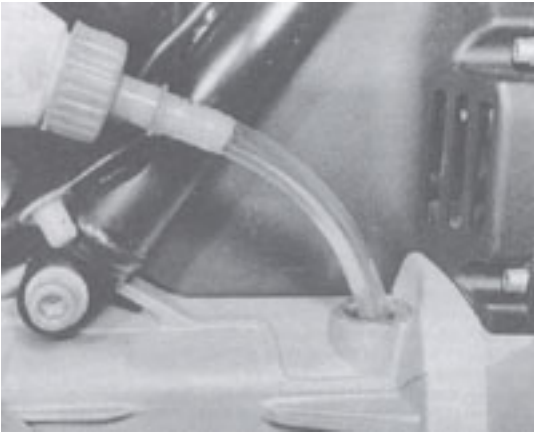

Use good quality oil of specified type when topping up

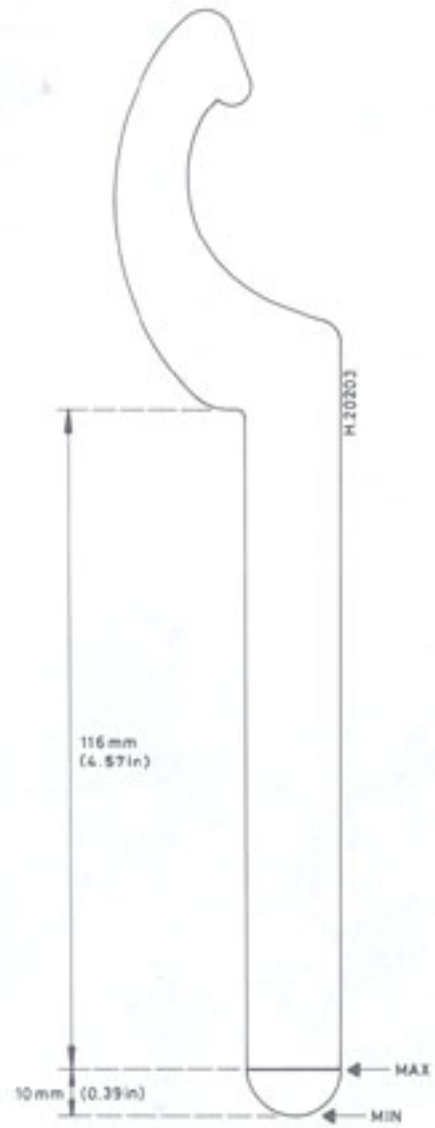

Gearbox oil level dipstick

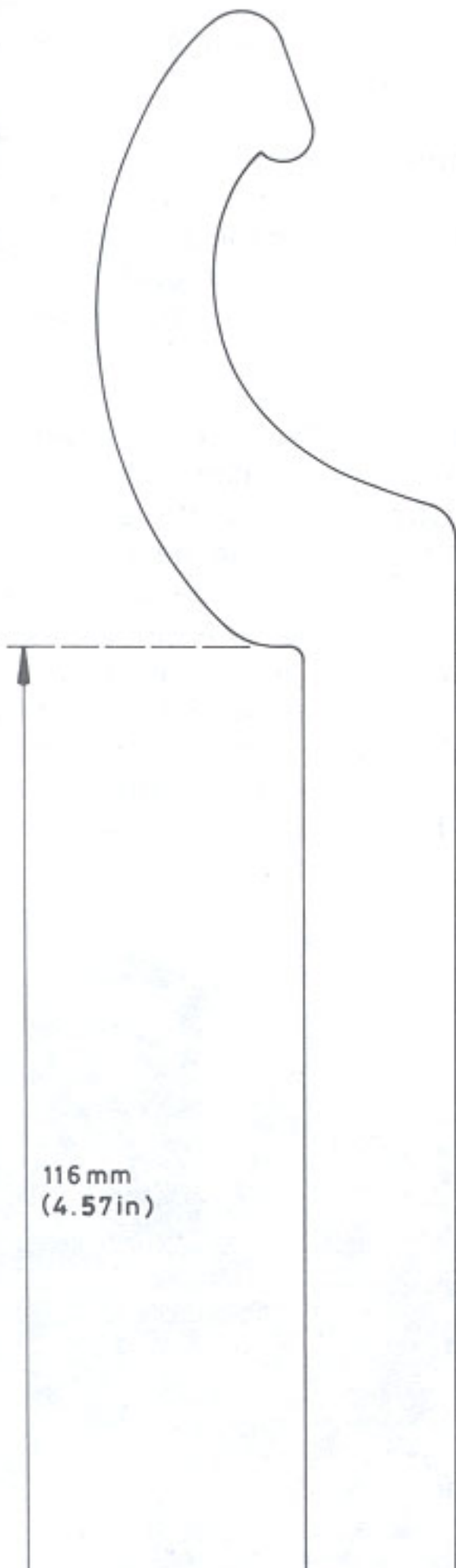

H.20203

116 mm
(4.57 in)

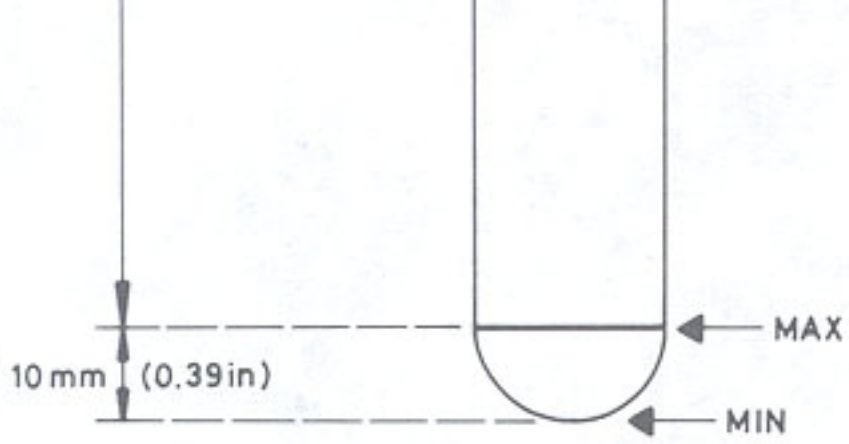

Gearbox oil level dipstick

3. Check the final drive case oil level

With the machine supported on its center stand on level ground, remove the filler plug from the final drive case. The oil level should be up to the bottom thread of the filler plug orifice ie 12 mm (0.47 in) below the machined filler plug sealing surface - the filler plug must not dip into the oil. Remove any surplus oil using a syringe or similar, to prevent oil being blown an to the rear tire or brake components via the breather. If topping up is necessary, use only good quality ail of the specified type. Renew the sealing washer if it is damaged or worn and refit the filler plug, tightening it securely to the specified torque setting (where given). Wash off any spilt oil from the housing end swinging arm.



Remove final drive case filler plug to check oil level

4. Lubricate the controls and stand pivots

The front brake lever can be removed by unscrewing the locknut and unscrewing or tapping out (as applicable) the pivot pin or screw; withdraw the lever, noting the presence of any shims that may be fitted. The clutch lever can be withdrawn similarly, after the cable adjusters have been slackened and the cable end nipples have been withdrawn from their respective levers. Note that a slotted nipple retainer is fitted at the handlebar lever (also at the gearbox end on some models); this must not be allowed to drop clear and be lost.

To release the throttle cable, first remove the injector cover (where fitted), then rotate the cable pulley inwards and carefully disengage the cable end nipple from the pulley. Withdraw the cable from its stop on the throttle butterfly assembly and carefully pull it clear of the machine, noting exactly how it is routed; note particularly that the cable is routed over the top of the air filter top half/plenum chamber connecting hose. Removing the handlebar cover, if necessary, first withdraw the single screw clamping the right-hand switch cluster to the twistgrip assembly, then remove its single retaining screw and withdraw the twistgrip top cover, noting how its protruding tang locates with the twistgrip drum. Disconnect the cable end nipple from the slot in the block at the chain end, then withdraw the cable. On reassembly, grease liberally all twistgrip components, noting that the handlebar weights fitted to some models must be removed by slackening the screw which secures the expander bolt retaining system; be careful that the weight is not pushed so far against the twistgrip rubber on refitting that it drags and impairs free throttle movement. Before refitting the twistgrip top cover, align the mark on one of the twistgrip drum teeth with the line on the throttle pulley to ensure full throttle movement is available.

When refitting the throttle cable, be very careful to ensure that it is routed correctly with no kinks or sharp bends and that it does not foul or snag on any other component; check at all front fork positions. Particularly check that the outer cable does not foul the handlebar cover or any other component as it passes through the steering head area, also that there is a straight run from the outer cable stop on the throttle butterfly assembly

to the cable pulley; it may be necessary to renew the stop, if this is bent out of true. Open the throttle and check that it snaps quickly and easily shut at all handlebar positions. On some 1983 - 85 100 models (an authorized BMW dealer will have full details of the machines that may be affected) an additional earth wire should have been installed between the twistgrip/brake master cylinder assembly and the main frame earth point on the left-hand side of the frame top tube bracing gusset, to the rear of the steering head. If this wire is not installed and the stop lamp front switch should develop a short-circuit, since the handlebars are rubber-mounted and therefore insulated from the rest of the machine, the switch may earth through the throttle cable inner wire, causing it to heat up and drag on the outer cable. If in any doubt about the throttle operation, have the machine checked by an authorized BMW dealer.

To remove the choke (fast idle) control cable slacken its locknut and unscrew the cable adjuster at its lower end, then release the cable end nipple from the butterfly operating linkage. At the handlebar end, rise off the black plastic cap and unscrew the large retaining screw to dismantle the lever. Note how the lever detent spring is fitted.

Check all lever pivot components for wear, renewing any that are damaged or worn and grease them thoroughly on refitting. Check the control cable inner wires for signs of fraying, poorly-soldered nipples and other damage, and the cable outers for signs of chafing, damaged or broken covers, or frayed or damaged ends. If any cable appears to be damaged or worn, or if it is stiff and jerky in operation, it must be renewed immediately. All the cable inner wires are lined with nylon or a similar material which must not be lubricated with oil. If the cables become stiff through old age, wear, or damage, they must be renewed, although in some cases the application of one of the modern 'dry' lubricants may help. Finish off control lubrication by applying a few drops of engine oil or light machine oil to all nipples and control pivots, and all adjuster threads. Apply WD40 or CRC5-56 to all locks and switches. Working as described in the relevant Section of Chapter 2, Chapter 7 and Chapter 9, dismantle, clean and grease at regular intervals the stand pivots, the clutch release mechanism and the brake operating linkages. Check also the footrests and all return springs for security and correct operation.

5. Check and adjust the valve clearances

This operation is described in two sub-sections since while checking the clearances is within the scope of any owner, adjusting them is a different matter. Owners are advised to read the instructions to get some idea of what is involved and to then decide whether to attempt all or part of the work themselves, or whether to take the machine to a dealer. Note that while the clearances should be checked carefully at the interval, this system of valve clearance adjustment does not usually require resetting until a much greater mileage has been covered.

5.1 Checking the valve clearances

The engine must be cold before the valve clearances can be checked accurately. First remove the spark plugs and the engine left-hand outer (cylinder head) cover. See Chapter 1 Select top gear and rotate the crankshaft to the desired position by turning the rear wheel.

The valve clearances must be measured at the base circle of the cam lobe i.e. with the lobe pointing directly away from the valve stem. This position is approximately just before Top Dead Center (TDC) on the compression stroke for the exhaust cam and just after it for the intake cam. To find TDC on the compression stroke, rotate the crankshaft until the (upper) intake cam lobe for any particular cylinder has opened and closed its valve, then shine a torch down the spark plug aperture and slowly turn the rear wheel until that piston comes to the top of its stroke. It is easiest to work methodically, starting from number 1 (front, or cam chain end) cylinder and to then work backwards i.e. for 100 models from number 1 cylinder at TDC a half turn of the crankshaft brings number 3 cylinder to TDC, a further half turn brings number 4 to TDC, and a final half turn brings number 2 to TDC.

Note that if the ignition trigger assembly cover is removed the crankshaft can also be rotated (anticlockwise, looking at the trigger from the front of the machine) by means of an Allen key applied to the rotor retaining bolt. Whichever method is used, position the cams as described and use a feeler gauges to measure carefully the clearance between each cam lobe and the shim sitting on its respective cam follower recess. The correct thickness feeler gauge blade will be a tight sliding fit between the two components. Carefully record all clearances on a sheet of paper.

If the clearance at any valve is outside the specified range, the shim must be replaced by a thicker or thinner one, as appropriate.

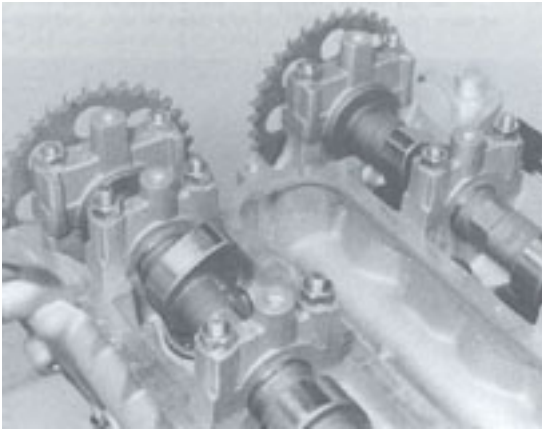

Cylinder is at TDC on compression stroke when piston is at the top of the bore with both valves closed.
number 1 cylinder, 100 model shown

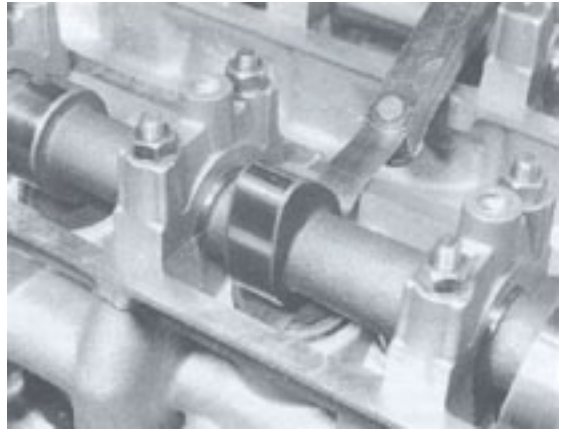

Valve clearance is measured with cam lobe pointing away from valve as shown

5.2 Adjusting the valve clearances with service tools

The shims are changed by pressing down the cam follower (tappet bucket) using a specially-shaped depressor lever, BMW part number 11 1 721, and holding it down using a spacer, BMW tool number 1 1 1722; the shims can then be extracted using a pointed instrument or a pair of large tweezers or needle-nosed pliers. If these tools are available, proceed as follows.

Position the cam lobe so that it is pointing directly away from the valve to be adjusted, then rotate the cam follower so that the notch in its raised edge faces in (towards the center of the head); later models have followers with two notches to facilitate this. Insert the depressor lever under the camshaft next to the lobe, check that it bears fully on the shim, then press the handle upwards (intake valve) or downwards (exhaust valve) until it touches the cylinder head wall, thus pressing the valve assembly into the cylinder head. Fit the spacer so that it locks securely under the camshaft with its foot bearing squarely on the edge of the follower i.e. clear of the shim. **It is essential** that the spacer rests squarely on the edge of the follower, or it may slip and lock the follower in place by raising a burr on the cylinder head.

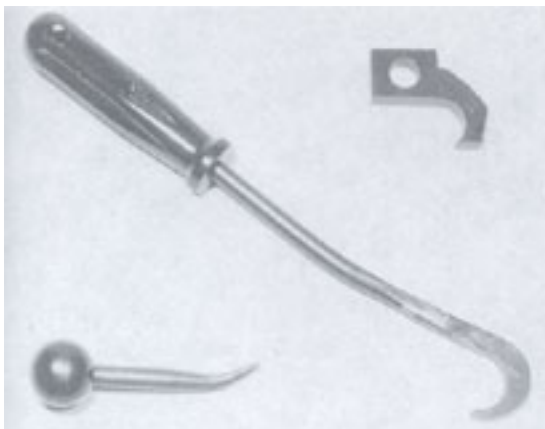

Valve clearance adjustment requires special tools if camshafts are not to be removed

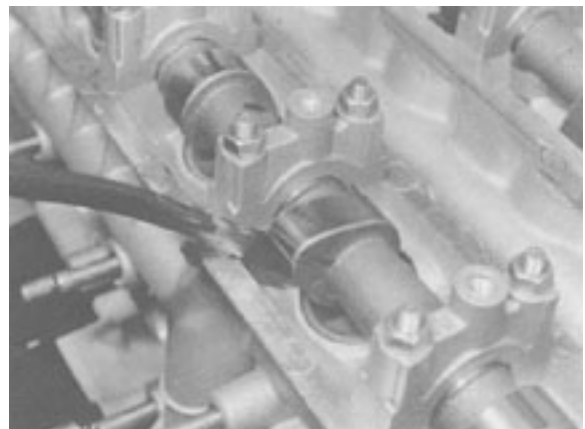

Hook depressor lever under camshaft and press lever downwards for exhaust

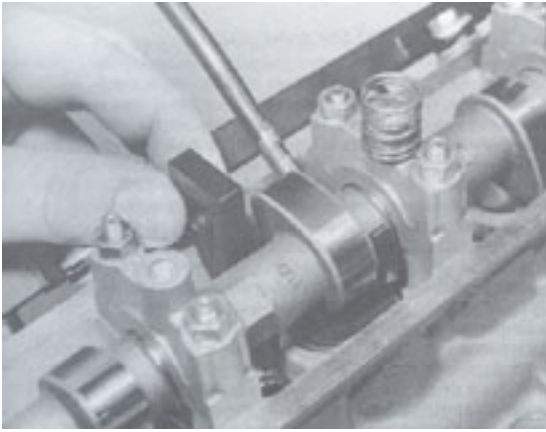

..... or upwards for intake until valve assembly is depressed sufficiently for spacer to be fitted

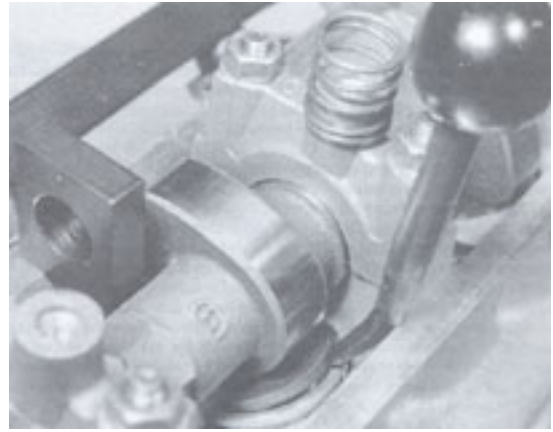

Shim can be prised out via notch in cam follower rim -
- check spacer bears securely on follower only



Number painted on shim underside indicates thickness, in this case 2,05 mm

Using a pointed instrument, prise the shim out of its recess and withdraw it, noting the number painted on its underside.

Shims are available in increments of 0.05 mm (0.0020 in) in a range of thickness from 2.00 - 3.00 mm (0.0787 - 0.1181 in).

To adjust a valve's clearance, note the thickness of the present shim; if the painted number has been polished away measure the shim with a micrometer or vernier caliper or similar and record it.

If the measured clearance was too small, select the next size thinner shim, install it and recheck the clearance; if the clearance was too large a thicker shim must be installed. The clearance does not usually require adjusting by more than one shim size. Note that as a picture of the valve gear is built up it may be possible to reduce the cost by swapping shims between valves so that the smallest number of new shims has to be purchased. Refit the shims ensuring that their painted numbers are facing downwards so that they are not polished away by the cam lobe, and that each shim is seated fully in its recess. Refit the depressor lever and push down the valve assembly, withdraw the spacer and slowly move the depressor lever to release the cam follower. Rotate the follower through a full circle to ensure that the new shim is securely seated at all points, then measure the clearance again and record it. Repeat the process for all other valves.

When all clearances have been checked and adjusted, turn the engine over several times to settle all components (if the starter motor is used be careful to protect the ignition system components as described in (Chapter 6), then recheck all clearances to ensure that none have altered through shims settling. If all is well, refit the cylinder head cover as described in Chapter 1. Note that if the clearances required significant alteration, the throttle butterfly assembly synchronization should be checked as described in Chapter 5.

Note: Always record the date and mileage of each check and all relevant information i.e. original clearance, original shim thickness, new shim thickness and final clearance. In this way an extremely accurate picture can be obtained of the rate of wear of the valve gear, until it is almost possible to predict when a particular valve will need adjusting. Obviously if the pattern changes suddenly, the reason should be investigated before serious trouble is encountered. Note that with this system of valve clearance adjustment wear of the valve gear is minimal and it is more likely that thinner shims will be required to compensate for wear at the valve seat. Once the shims have been properly set up after running in, adjustment should be only rarely required, thus offsetting the extra expense of the system.

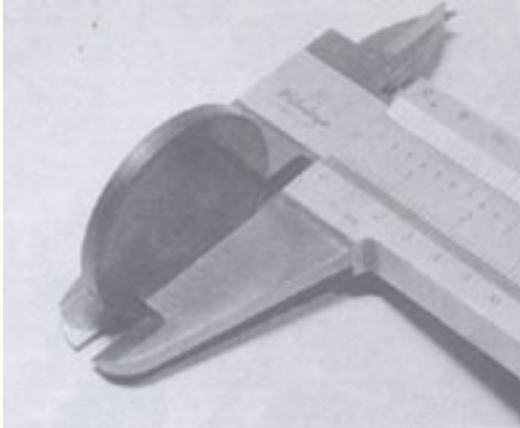

Measure shim thickness with caliper or micrometer if number is erased

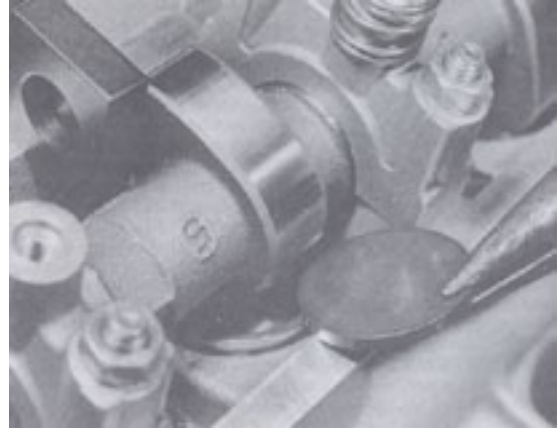

Fit shims with number downwards and check that they are seated fully in their followers

5.3 Adjusting the valve clearances without service tools

Owners who do not have access to the service tools mentioned above should note that it is possible to adjust the clearances without them, but that this involves a much longer procedure which requires very accurate measurements of the clearances. The task is outlined below; refer to the relevant Sections of Chapter 1 for full details.

Measure and record carefully the clearances of all valves (see section 5.1). If any require adjustment, remove the engine front and right-hand outer covers and withdraw the camshafts. See Chapter 1.

Note that only one camshaft should be removed at a time, to avoid confusion, and that great care must be taken to avoid shims dropping clear and becoming mixed up; remove the camshaft very slowly and substitute a wooden dowel or similar to retain the shims as soon as possible.

Measure or note the shim thicknesses and obtain thinner or thicker shims as described above, and refit them securely to the cam follower recesses.

When all valves have been adjusted, refit the camshafts, set the valve timing and refit the cam chain, then re-check all valve clearances. If the work has been sufficiently accurate, the clearances will be correct; if not, repeat the procedure until all are correct. As described above, make a careful note of all relevant information so that an accurate picture can be built up of the rate of valve or valve gear wear. When adjustment is complete, refit the engine outer covers and other disturbed components. Note that if the clearances required significant alteration it will be necessary to check the synchronization of the throttle butterfly assembly. See Chapter 5.

6. Check and adjust the spark plugs

Either perform this task when the engine is cold, or take great care to prevent personal injury through burning one's hands on the hot cylinder head. Remove the three retaining Allen screws and withdraw the spark plug cover plate from the middle of the engine left-band outer (cylinder head) cover. Noting exactly how the leads are routed, pull off each spark plug suppressor cap using a heavy pair of pliers applied to the tab protruding from each cap. Clean off any particles of dirt or other foreign matter from the spark plug channel, then unscrew the spark plugs, keeping them clearly identified by cylinder number. First use feeler gauges (see spark plug maintenance), preferably of the wire type for accuracy, to measure the gap between the spark plug electrodes; BMW state that the ignition system is so sensitive to spark plug condition and electrode gap that the plugs must all be renewed if the electrodes of any one spark plug have been eroded to a gap of 0.8 mm (0.032 in) or more. If this is found to be the case, or if the plugs are in any way suspect, new spark plugs of the specified make and type must be purchased and fitted. Note that if this particular make is difficult to obtain locally, the advice of an authorized BMW dealer should be sought; provided that exactly the equivalent heat range and type is obtained from a good quality brand, spark plugs of alternative makes may be used eg NGK07EA. Fit them as described below.

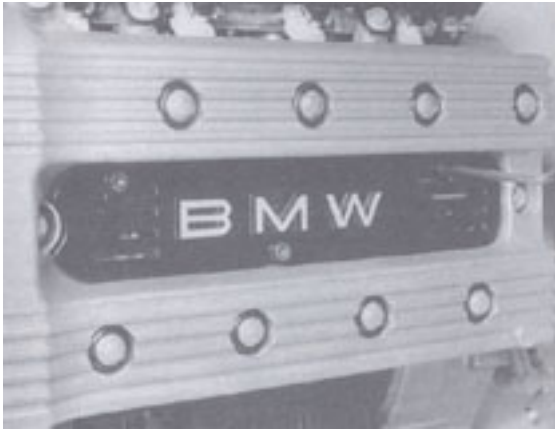

Remove spark plug cover plate from cylinder head cover.....

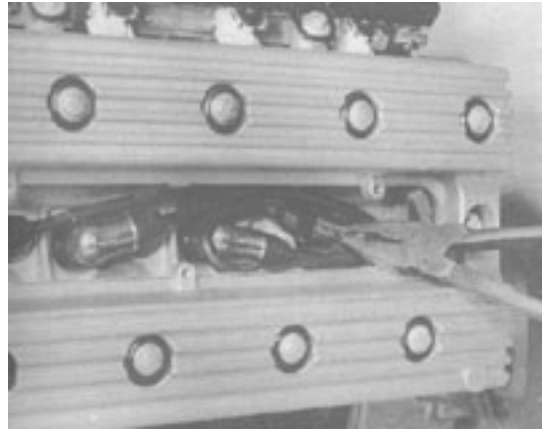

..... and use pliers to pull of suppressor caps, noting exactly how HT leads are routed

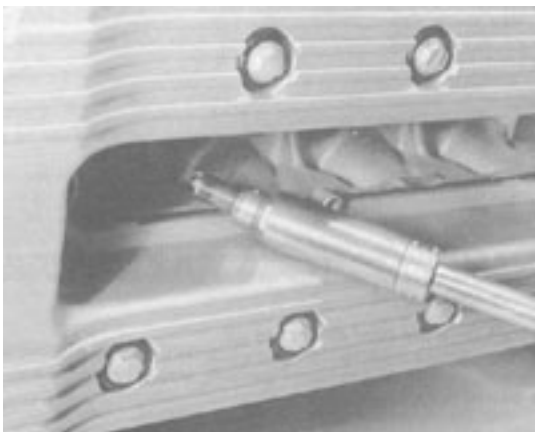

Spark plugs must be renewed as a set if any gap has worn to beyond the service limit

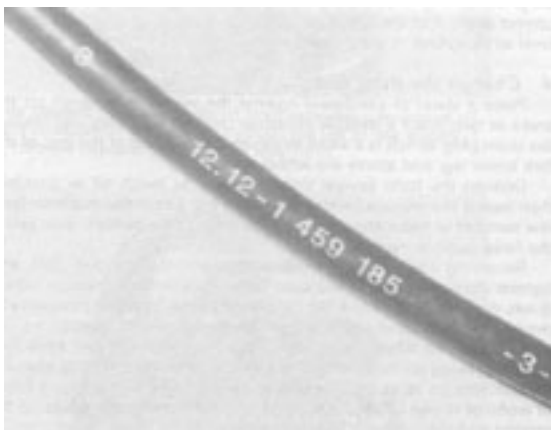

HT leads are numbered to assist identification on refitting

If the spark plugs are still serviceable, carefully compare the appearance of their electrodes with the accompanying color section (see spark plug conditions 1 or (spark plug condition 2) and note any information which can be obtained from this. If any plug appears to show a fault, seek expert advice as soon as possible; do not forget to take the old plugs with the machine to an authorized BMW dealer. The standard grade of spark plug should prove adequate in all normal use and a change of specification (such as fitting a hotter or colder grade of plug) should not be made without expert advice. Clean the electrodes by carefully scraping away the accumulated carbon deposits using a small knife blade or small files end abrasive paper; take care not to bend the center electrode or to chip or damage the ceramic insulator. The cleaning of spark plugs on commercial sand-blasting equipment is not recommended due to the risk of abrasive particles being jammed in the gap between the insulator and the plug metal body, only to fall clear later and drop into the engine; any plug that is so heavily fouled should be renewed.

Once clean, file the opposing faces of the electrodes flat using a small fine file. A magneto file or even a nail file can be used for this purpose. Whichever method is chosen, make sure that every trace of abrasive and loose carbon is removed before the plug is refitted. If this is not done, the debris will enter the engine and can cause damage or rapid wear.

Whether a cleaned or new plug is to be fitted, always check the electrode gap before it is installed. Use a spark plug adjusting tool or feeler gauges to measure the gap, and if adjustment is required, bend the outer, earth electrode only. Never bend the center electrode or the porcelain insulator nose will be damaged.

Before the plug is fitted, apply a fine coat of PBC or molybdenum disulphide grease to the threads. This will help prevent thread wear and damage. Fit the plug finger-tight, then tighten it by a further 1/4 turn only, to ensure a gas-tight seal. Beware of over tightening, and always use a plug wrench or socket of the correct size; tighten all plugs to the specified torque wrench setting, where possible.

Never over tighten a spark plug otherwise there is risk of stripping the thread from the cylinder head, especially as it is cast in light alloy. A stripped thread can be repaired without having to scrap the cylinder head by using a 'Helicoil' thread insert. This is a low-cost service, operated by a number of dealers.

When refitting the spark plug suppressor caps, be careful to ensure that the HT leads are correctly routed; note that the leads are numbered as a further aid to identification.

6.1 Spark plug maintenance



Checking plug gap with feeler gauges

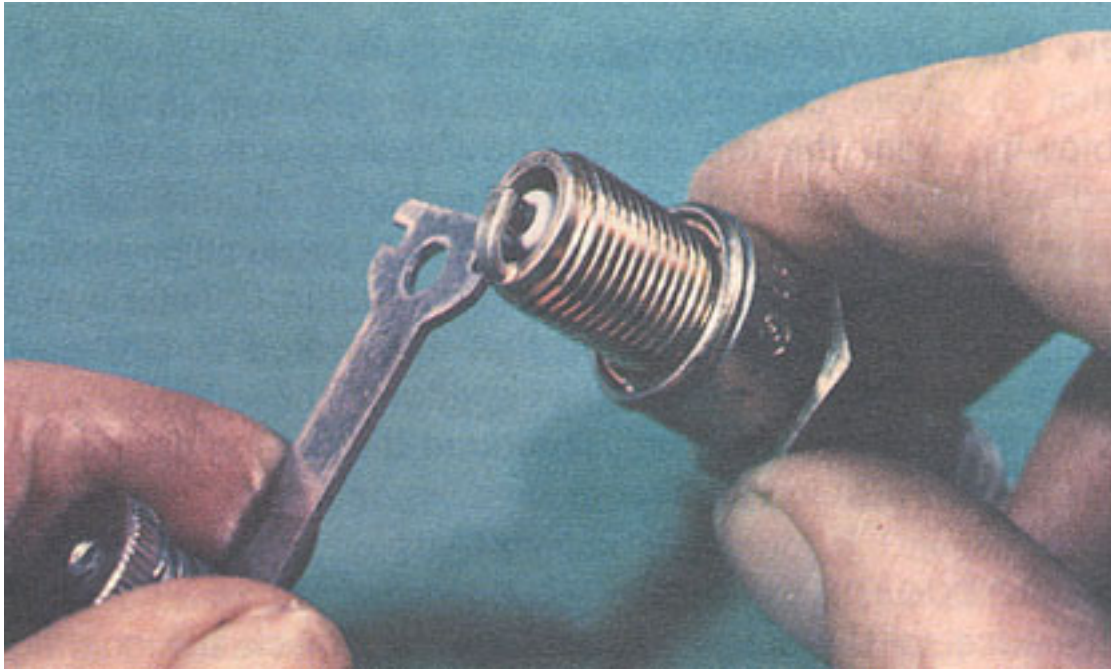

Altering the plug gap. Note: use the correct tool

6.2 Spark plug conditions



A brown, tan or grey firing end is indicative of correct engine running conditions and the selection of the appropriate heat rating plug



White deposits have accumulated from excessive amounts of oil in the combustion chamber or through the use of low quality oil. Remove deposits or a hot spot may form



Black sooty deposits indicate an over-rich fuel/air mixture, or a malfunctioning ignition system. If no improvement is obtained, try one grade hotter plug

6.3 Spark plug conditions



Wet, oily carbon deposits form an electrical leakage path along the insulator nose, resulting in a misfire. The cause may be badly worn engine or a malfunctioning ignition system.



A blistered white insulator or melted electrode indicates over-advanced ignition timing or a malfunctioning cooling system.
If correction does not prove effective, try a colder grade plug.



A worn spark plug not only wastes fuel but also overloads the whole ignition system because the increased gap requires higher voltage to initiate the spark. This condition can also affect air pollution.

7. Final inspection

Working as described in the relevant sections of Routine Maintenance, or in the relevant Chapters, work methodically round the machine checking the following items:

- a. Check the rear wheel mounting bolts are tightened to the specified torque wrench setting
- b. Check the operation of the clutch and gear change mechanism
- c. Check the steering
- d. Check the wheels, brakes and tires
- e. Check all lights and other electrical components and instruments
- f. Check the idle speed and adjust if necessary

8. Air filter

Note that under severe operating conditions it may be necessary to clean or even renew the air filter element at this interval. See the major service operation.

Major service

- 1 [Change the engine oil and filter](#)
 - 2 [Change the gearbox oil](#)
 - 3 [Change the final drive case oil](#)
 - 4 [Change the front fork oil](#)
 - 5 [Clean the speedometer impulse transmitter](#)
 - 6 [Renew the air filter element](#)
 - 7 [Check the cooling system](#)
 - 8 [Check and adjust the clutch](#)
 - 9 [Lubricate the controls and stand pivots](#)
 - 10 [Check the battery](#)
 - 11 [Check and adjust the valve clearances](#)
 - 12 [Renew the spark plugs](#)
 - 13 [Check the fuel system](#)
 - 14 [Check and overhaul the brakes](#)
 - 14-1 [Check and renew the brake fluid](#)
(disc brakes - front and rear)
 - 14-2 [Check and renew the brake pads](#)
(disc brakes - front and rear)
 - 14-3 [Check the Drum rear brake](#)
 - 15 [Check the wheels and wheels bearings](#)
 - 16 [Check the steering head bearings](#)
 - 17 [Check the swinging arm pivot bearings](#)
 - 18 [Final inspection](#)
 - 19 [Renew the fuel filter](#)
-

1. Change the engine oil and filter

Refer to the minor service operation

2. Change the gearbox oil

The machine must be taken on a journey of sufficient length to warm up the gearbox to normal operating temperature before the oil is drained.

With the machine supported on its center stand on level ground, remove the filler and drain plugs and allow the oil to drain into a suitable container; a cardboard chute should be fabricated to direct the oil into the container, away from the center stand. While the oil is draining, clean the drain plug carefully, wiping any metal particles off its magnetic insert, and renew its sealing washer if it is worn, flattened or damaged. When the oil is fully drained, refit the drain plug and tighten it securely to the specified torque wrench setting, where available.

Fill the gearbox with the correct amount of the specified type and viscosity of oil, then check the oil level as described in the minor service operation.

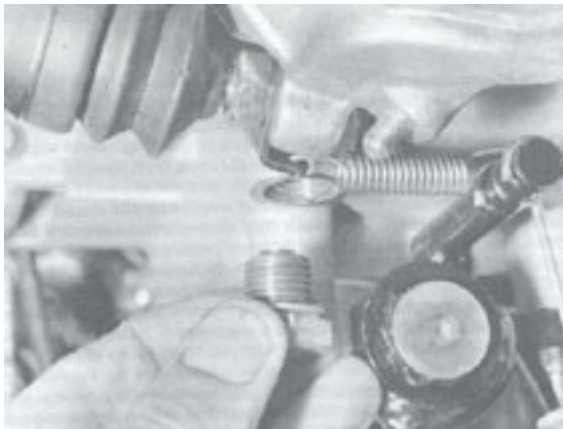

Gearbox oil drain plug is fitted with a magnetic insert
Clean carefully

3. Change the final drive case oil

The machine must be taken on a journey of sufficient length to warm up the final drive to normal operating temperature before the oil is drained.

With the machine supported on its center stand on level ground, remove the filter and drain plugs and allow the oil to drain into a suitable container. Use a sheet of cardboard to keep the oil off the rear wheel and tire. Renew the plug sealing washers if they are damaged or flattened, and clean both plugs; wipe any metal particles from the drain plug magnetic insert. When the oil has fully drained, refit the drain plug, tightening it to the specified torque setting and pour in the correct amount of the specified type and viscosity of oil. Check the oil level as described in the minor service.

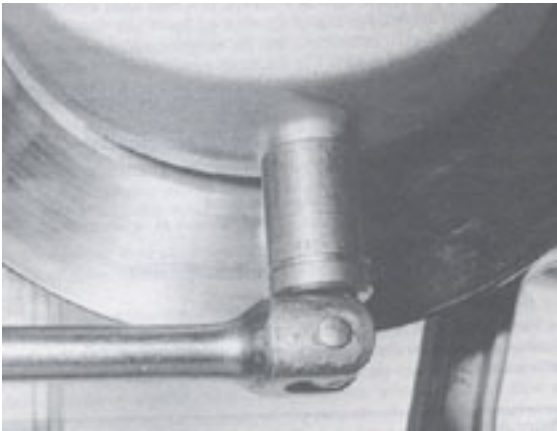

Final drive drain plug is situated on underside of final drive case

4. Change the front fork oil

Place a sheet of cardboard against the wheel to keep oil off the brake or tire, place a suitable container under the fork leg and remove the drain plug which is a small hexagon-headed bolt at the rear of the fork lower leg, just above the wheel spindle.

Depress the forks several times to expel as much oil as possible, then repeat the process on the remaining leg. Leave the machine for a few minutes to allow any residual oil to drain to the bottom, then pump the forks again to remove it.

Renewing their sealing washers if worn or damaged, refit and tighten the drain plugs to the specified torque wrench settings, where given, then remove the fork leg top plastic plugs; it may be necessary to remove the handlebar cover to gain adequate working space.

Unscrew the Allen screw filler plugs from the center of each fork top plug, using an open-ended spanner to hold the top plug, then lift the machine on to its center stand on level ground and wedge a block of wood or similar under the sump so that the front wheel is clear of the ground and the forks are fully extended.

Fill each leg with the specified amount of one of the recommended brands of oil (see Chapter 7). Do not use ordinary fork oil; BMW forks are designed to work with oils of (approximately) SAE 3 viscosity. Most proprietary fork oils are up to 10 times thicker than this and will produce a very stiff ride. Check the oil level by inserting a length of winding rod 1 meter (40 in) long by 5 mm (0.2 in) diameter into the fork leg; ensure that the level is the same in both fork legs. Refit the filler plugs, tightening them to the specified torque wrench setting, where given, followed by the plastic top plugs and/or any other disturbed components. Push the machine off its stand, apply the front brake and pump the forks up and down 5 - 10 times until the damping effect can be felt to be fully restored.

5. Clean the speedometer impulse transmitter

Remove its single retaining screw and carefully prise the impulse transmitter out of the final drive case. Renew its sealing O-ring if worn or damaged and wipe the unit clean of oil and any dirt or foreign matter. Check it for signs of damage. On refitting, tighten the retaining screw securely but do not over tighten it.

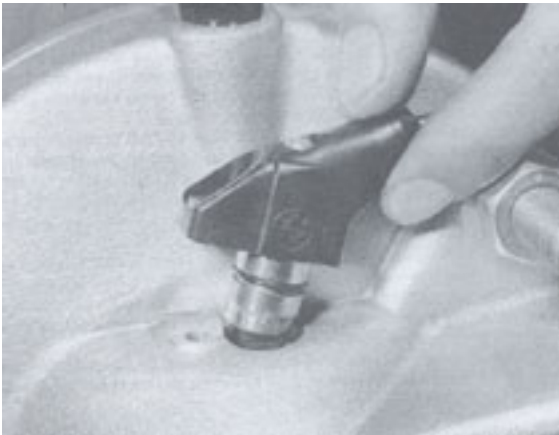

Speedometer impulse transmitter must be removed at regular intervals for cleaning

6. Renew the air filter element

Note that in severe conditions the air filter element should be cleaned, blowing from the top surface downwards with a blast of compressed air and removing any large particles of dirt with a soft-bristled brush, at the minor service interval. At the major service interval the element should be removed as described in Chapter 5 and discarded. Fit a new element, ensuring that it is seated correctly, as described, and secure the filter top half by springing the retaining clips into place. A light application of grease around the sealing edges will help provide a good seal in very wet or dusty conditions.



Ensure air filter element is correctly refitted to prevent entry of dirt into engine



Filter casing top half is secured by spring clips

7. Check the cooling system

With reference to Chapter 4 of this Manual, check the cooling system at regular intervals, looking for signs of leakage, damage or wear to any of the system's components. Check the coolant level and top up, if necessary. Note that the coolant must be renewed at least every two years, as described.

8. Check and adjust the clutch

The clutch is adjusted correctly if there is the correct specified amount of free play in the cable measured between the handlebar lever butt end and the handlebar clamp and the clutch operates smoothly with no sign of slip or drag.

To adjust the clutch, slacken the handlebar adjuster locknut then rotate the handlebar adjuster as necessary until the distance between the forward edge of the clutch operating lever on the gearbox and the rear edge of the cable outer cover on the gearbox housing (ie the exposed length of clutch cable inner wire) is $75 + 1$ mm (2.95 ± 0.04 in). Tighten the handlebar adjuster locknut.

Slacken the locknut of the adjuster set in the clutch operating lever at the rear of the gearbox and slacken the adjuster screw by one or two full turns to check that there is no pressure on it, then screw it in until light resistance is encountered; do not over tighten the screw. Hold the screw steady and tighten the adjuster locknut securely. Use the handlebar adjuster to set the specified clearance at the lever, then tighten its locknut; operate the clutch lever once or twice to settle the cable. Check that the adjustment has remained the same, resetting it if necessary. Apply a few drops of oil to all cable end nipples, adjuster threads and lever pivots.

If the clutch still shows signs of slipping or dragging, or if it is very sudden in action, it must be dismantled for examination. On reassembly, the components should be lubricated, (where specified) to ensure a smooth action. Refer to Chapter 2.

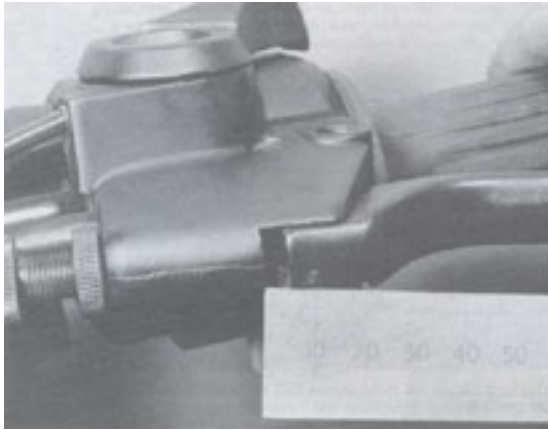

Measuring clutch cable free play
100 model shown

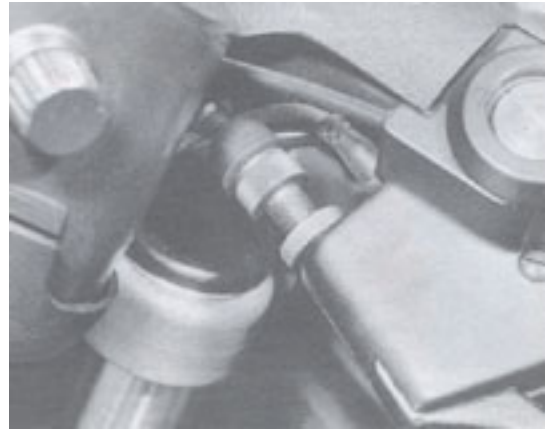

Use cable handlebar adjuster
to set...

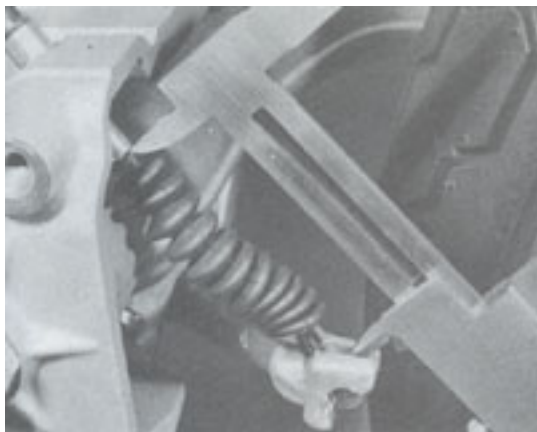

... correct length of exposed cable
inner wire, as shown



Clutch operating lever adjuster is used
to set release mechanism

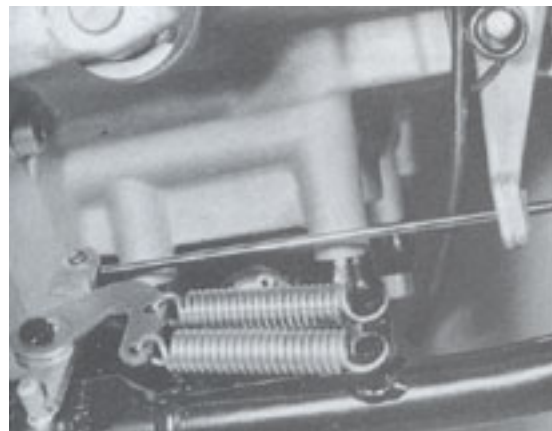

Where fitted, set side stand linkage so that
free play is just eliminated with stand down

9. Lubricate the controls and stand pivots

Refer to the minor service operation.

10. Check the battery

Refer to the daily (pre-ride) check, item 10

11. Check and adjust the valve clearances

Refer to the minor service operation.

12. Renew the spark plugs

The spark plugs should be renewed at this interval regardless of their apparent condition as they will have passed peak efficiency.

Check that the new plugs are of the correct type and that they are correctly gapped before fitting them.

13. Check the fuel system

With reference to the relevant Sections of Chapter 5, check all pressure hoses for signs of leaks, check the adjustment end operation of the throttle and choke control cables and check the idle speed. Remember that if the valve clearances have been altered significantly, the synchronization of the throttle butterfly assemblies should be checked, and adjusted if necessary. Note that the fuel filter must be renewed at regular intervals (see item 19).

19. Renew the fuel filter

Note that the full-flow filter element between the fuel pump and the fuel rail must be renewed at every second major service or, if the fuel used is of poor quality, at every major service. Refer to Chapter 5.

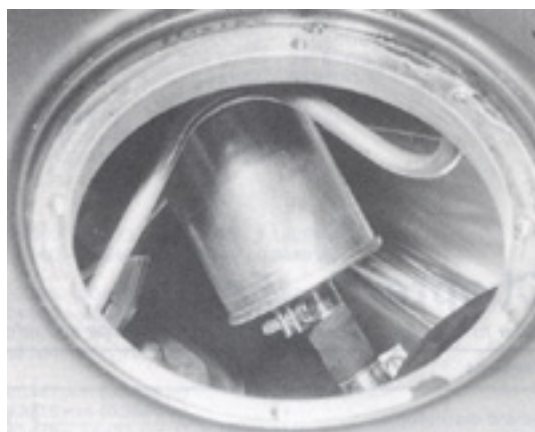

Fuel filter must be renewed at every second major service, or sooner if necessary

18. Final inspection

Proceed as described for the minor service operation but check also that the engine mountings, exhaust system mountings, rear suspension unit mountings and stand pivots and mountings are all securely fastened. Where possible, use a torque wrench to ensure that all nuts and bolts are tightened to their specified torque settings.

17. Check the swinging arm pivot bearings

With the machine supported on its center stand on level ground, check for play by pushing and pulling alternately on the end of the swinging arm, while holding the frame firmly. If any free play is discovered, remove the left-hand footrest plate and slacken the swinging arm adjustable pivot stub locknut.

Tighten the adjustable pivot stub as hard as possible, using hand pressure alone on an ordinary Allen key, then slacken it fully and retighten it to the specified torque wrench setting. Hold the stub in that position and tighten the locknut securely, to its specified torque wrench setting, if possible.

If play still exists, one or both of the pivot bearings are worn and must be renewed.

Note that the swinging arm must be removed (see Chapter 8) to permit the pivot bearings to be greased.

16. Check the steering head bearings

The steering head should be checked for play with the motorcycle on the center stand and the front wheel supported clear of the ground. Grasp the fork lower legs at the bottom and alternately push and pull, feeling for any play in the bearings. The forks should fall easily to either side, if moved slightly off centre. On 75 models the Fluidbloc retaining screws must first be removed. If adjustment proves to be necessary, remove the handlebar cover and the fuel tank. On models fitted with frame-mounted fairings, remove the fairing inner panels if they prevent access to the fork yoke clamp bolts and to the steering head area. On all models, slacken fully the bottom yoke clamp bolts; the fork stanchions must be free to move up or down slightly in the bottom yoke.

On all 100 models and early 75 models slacken the steering stem top bolt and rotate the knurled, circular adjusting nut under the fork top yoke until the setting is correct, then tighten the top bolt, to its specified torque wrench setting if possible, to secure the nut. Tighten the bottom yoke pinch bolts and refit all disturbed components.

On later 75 models slacken the adjuster sleeve locknut and adjuster sleeve, then rotate the knurled, circular adjusting nut under the fork top yoke until the setting is correct, then tighten the adjuster sleeve to its specified torque wrench setting, followed by tightening the locknut to its torque wrench setting. Tighten the bottom yoke pinch bolts and refit all disturbed components.

On all models, check that all fasteners are tightened securely to their specified torque wrench settings, if possible, then check that the forks move smoothly from lock to lock with no traces of stiffness or of free play.

15. Check the wheels and wheel bearings

Wheels

Carefully check the complete wheel for cracks and chipping, particularly at the spoke roots and the edge of the rim. As a general rule a damaged wheel must be renewed as cracks will cause stress points which may lead to sudden failure under heavy load. Small nicks may be radiused carefully with a fine file and emery paper (No 600 - No 1000) to relieve the stress. If there is any doubt as to the condition of a wheel" advice should be sought from a reputable dealer or specialist repairer.

Each wheel is covered with a coating of lacquer or paint to prevent corrosion. If damage occurs to the wheel and the finish is penetrated, the bared aluminum alloy will soon start to corrode. A whitish gray oxide will form over the damaged area, which in itself is a protective coating. This deposit however, should be removed carefully as soon as possible and a new protective coating applied.

Check the lateral run out at the rim by spinning the wheel and placing a fixed pointer close to the rim edge. If the maximum run out is greater than 0.5 mm (0.02 in) the manufacturer recommends that the wheel be renewed. If warpage was caused by impact during an accident, the safest measure it to renew the wheel complete. Worn wheel bearings may cause rim run out. These should be renewed.

Note that impact damage or serious corrosion has wider implications in that it could lead to a loss of pressure from the tubeless tires. If in any doubt as to the wheel's condition, seek professional advice.

Front wheel bearings

Support the machine on its center stand on level ground so that the wheel to be examined is clear of the ground (wedge a wooden block or similar under the sump to raise the front wheel). Grasp the wheel firmly at top and bottom and attempt to rock it from side to side about its spindle; if any play is discovered, the wheel bearings must be renewed. See Chapter 9.

Rear wheel bearings

Support the machine on its center stand on level ground so that the rear wheel is clear of the ground. Grasp the wheel firmly at the top and bottom and attempt to rock it from side to side about its center. If any play is discovered the machine should be taken to a BMW dealer for the bearings in the final drive to be checked. Note that there should be no discernible endfloat (axial play) at the wheel hub.

14. Check and overhaul the brakes

14-3 Check the drum rear brake

Note that the brake pedal height can be altered as required by setting the screw and locknut beneath the stop lamp rear switch; the pedal should be set so that it is as close as possible to the rider's foot in the normal riding position.

Adjustment is made by placing the machine on its center stand with the rear wheel clear of the ground, then tightening the adjuster nut at the rear end of the brake operating rod while spinning the wheel until a rubbing sound is heard as the shoes begin to contact the drum. From this point slacken the nut by 3 - 4 turns until the rubbing sound has ceased. This should produce free play of 15 - 25 mm (0.6 - 1.0 in) at the brake pedal tip.

Brake shoe friction material wear can be checked by reference to the external wear indicator (see accompanying illustration) attached to the brake camshaft. With the brake correctly adjusted and fully applied, the pointer should align with the 'Max' line cast on the final drive case. As the shoes wear, the pointer will gradually move downwards. If it aligns with the 'Min' line at any time or extends beyond it, the brake shoes are worn out and must be renewed. See Chapter 9.

Note that if the rear brake appears spongy or imprecise at any time, but especially after the wheel has been disturbed, it is possible that centralizing the brake components on the hub will effect an improvement. Slacken the rear wheel mounting bolts then spin the wheel and apply the rear brake firmly; maintain firm pressure while the mounting bolts are tightened securely to the specified torque setting.

At regular intervals check that the operating linkage is at its most efficient by ensuring that the angle formed between the brake rod and operating lever is less than 90° when the brake is firmly applied. If the angle is more than 90° at any time, the brake will not be as efficient; the operating lever must be removed from the camshaft splines, noting the position of the wear indicator pointer, and repositioned on the camshaft so that the angle is correct. This may require some trial and error to achieve the correct setting. Ensure that the operating lever is correctly refitted and securely fastened, that the wear indicator pointer is correctly aligned and that the brake is properly adjusted.

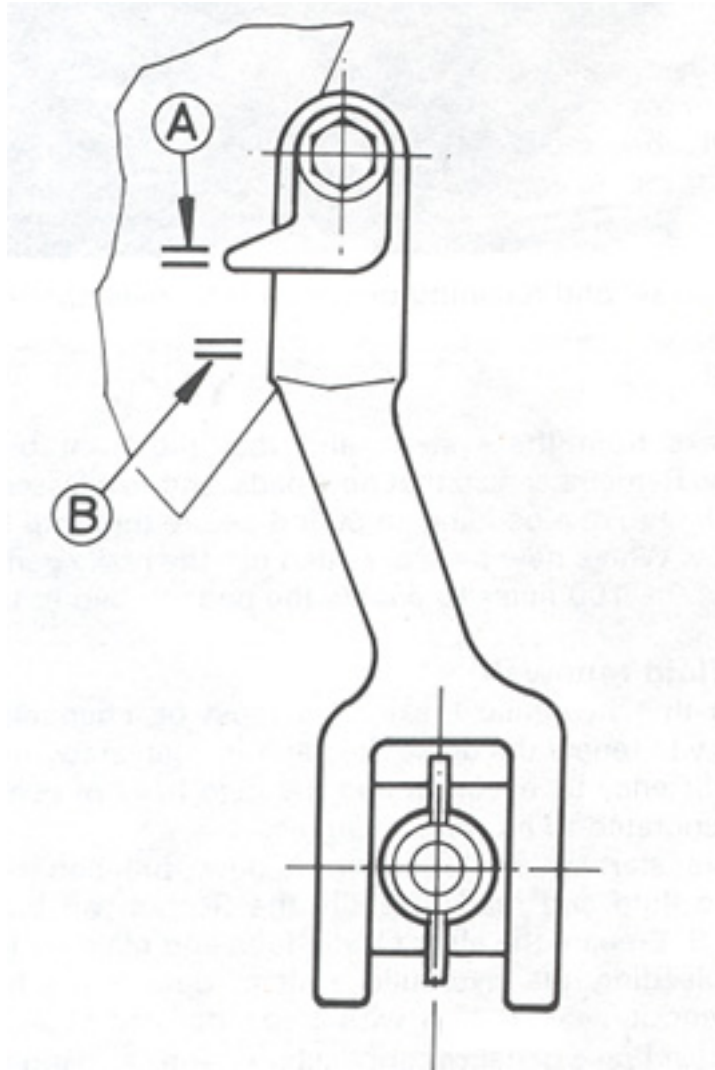

Drum rear brake wear limit marks

A = *Maximum friction material thickness*

B = *Minimum friction material thickness*

14. Check and overhaul the brakes

14-2 Check and renew the brake pads

To check the degree of pad wear, prise the plastic cover off each caliper body and assess the amount of friction material remaining on each pad; if either is worn at any point so that the metal backing is approaching contact with the disc, both pads must be renewed immediately. If the pads are so fouled with dirt that the friction material cannot be distinguished, or if oil or grease is seen on them, they must be removed for cleaning and examination. Unclip the plastic cover from the caliper and use a suitable drift to tap out the two pad retaining pins from the inside outwards; take care not to allow the retaining spring to fly off. Remove the central pin and withdraw both pads. If the pads are worn to a thickness of 1.5 mm (0.06 in) or less at any point, fouled with oil or grease, or heavily scored or damaged by dirt and debris, they must be renewed as a set; there is no satisfactory way of degreasing friction material. If the pads can be used again, clean them carefully using a fine wire brush that is completely free of oil or grease. Remove all traces of road dirt and corrosion, then use a pointed instrument to dig out any embedded particles of foreign matter. Any areas of glazing may be removed using emery cloth. On reassembly, if new pads are to be fitted, the caliper pistons must now be pushed back as far as possible into the caliper bores to provide the clearance necessary to accommodate the unworn pads. It should be possible to do this with hand pressure only. If any undue stiffness is encountered the caliper assembly should be dismantled for examination as described in Chapter 6.

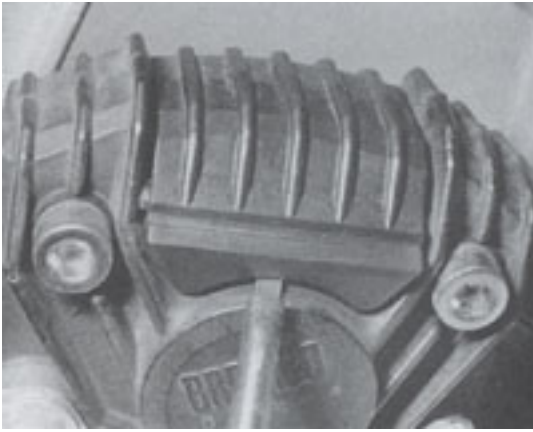

Pry plastic cover off caliper body to check brake pads

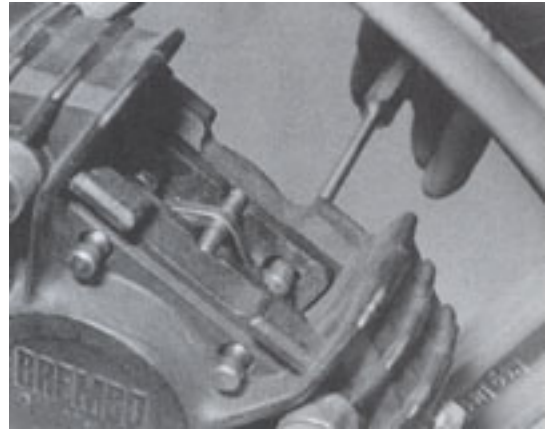

Use hammer and a long drift to tap out pad retaining pins from behind caliper



Remove pads, noting which way round each is fitted - check for uneven wear

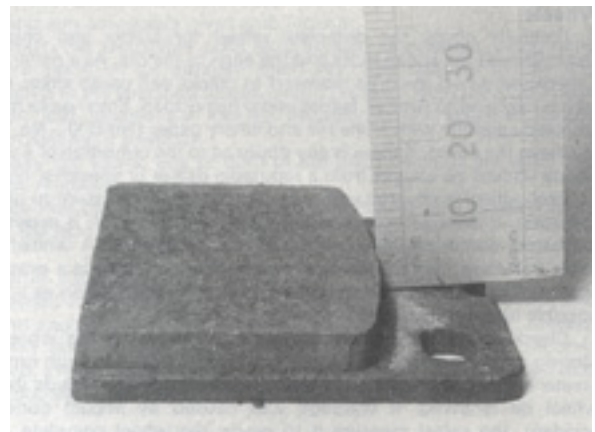

Pads must be renewed as a set if any is worn to service limit or less

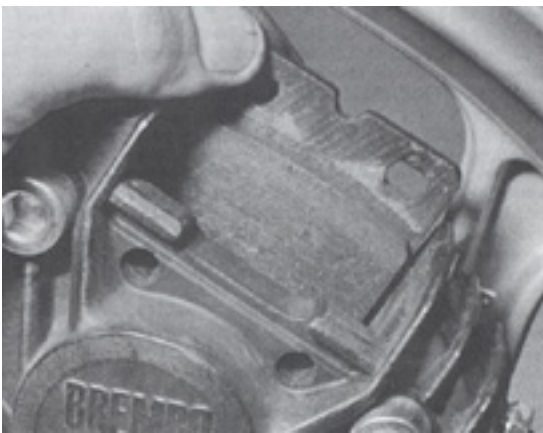

Ensure friction material is against disc when refitting brake pads

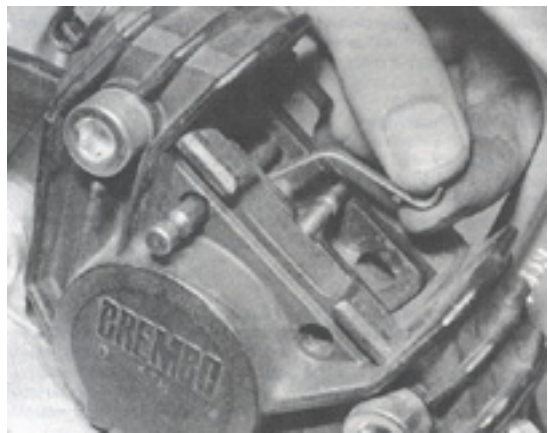

..... insert first retaining pin with spring, then refit central pin, as shown

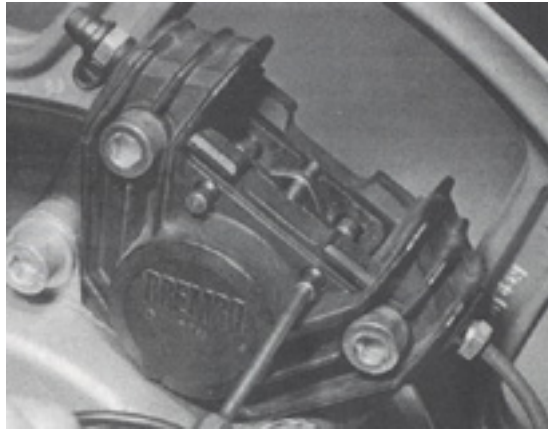

..... and tap second retaining pin into place,
over spring end

While pushing the pistons back, maintain a careful watch on the fluid level in the reservoir. If the reservoir has been overfilled, the surplus fluid will prevent the pistons returning fully and must be removed by soaking it up with a clean cloth. Take care to prevent fluid spillage. Apply a thin smear of caliper grease to the pad retaining pins. Take care to apply caliper grease to the metal backing of the pad only and not to allow grease to contaminate the friction material. Carefully fit the pads to the caliper and hold them in place while the first retaining pin (with the spring looped over it) is refitted. Place a central pin in the pad cutouts and press the spring over it and underneath the second retaining pin which should now be pressed into place. Refit the plastic cover. Apply the brake lever gently and repeatedly to bring the pads firmly into contact with the disc until full brake pressure is restored. Be careful to watch the fluid level in the reservoir; if the pads have been re-used it will suffice to keep the level above the lower level mark, by topping-up if necessary, but if new pads have been fitted the level must be restored to the upper level line described above by topping-up or removing surplus fluid as necessary. Refit the reservoir cover or cap, gasket (where fitted) and diaphragm as described above. Before taking the machine out on the road, be careful to check for fluid leaks from the system, and that the front brake is working correctly. Remember also that new pads, and to a lesser extent, cleaned pads will require a bedding-in period before they will function at peak efficiency. Where new pads are fitted use the brake gently but firmly for the first 50 - 100 miles to enable the pads to bed in fully.

14. Check and overhaul the brakes

14-1 Check the brake fluid

The hydraulic brake requires no regular adjustments; pad wear is compensated for by the automatic entry of more fluid into the system from the fluid reservoir. All that is necessary is to maintain a regular check on the fluid level and the degree of pad wear. To check the fluid level, turn the handlebars until the reservoir is horizontal (front brake only) and check that the fluid level, as seen through the reservoir body, is not below the lower level mark. Remember that while the fluid level will fall steadily as the pad friction material is used up, if the level falls below the lower level mark there is a risk of air entering the system; it is therefore sufficient to maintain the fluid level above the lower level mark, by topping-up if necessary. Do not top up to the higher level mark unless this is necessary after new pads have been fitted. If topping up is necessary, wipe any dirt off the reservoir, remove the retaining screws and lift away the reservoir cover or unscrew the cap, as appropriate, and withdraw the diaphragm. Use only good quality brake fluid of the recommended type and ensure that it comes from a freshly opened sealed container, brake fluid is hygroscopic, which means that it absorbs moisture from the air, therefore old fluid may have become contaminated to such an extent that its boiling point has been lowered to an unsafe level. Remember also that brake fluid is an excellent paint stripper and will attack plastic components; wash away any spilled fluid immediately with copious quantities of water. When the level is correct, clean and dry the diaphragm, fold it into its compressed state and fit it to the reservoir. Refit the reservoir cover or cap (and gasket, where fitted) and tighten securely, but do not over tighten, the retaining screws (where appropriate).

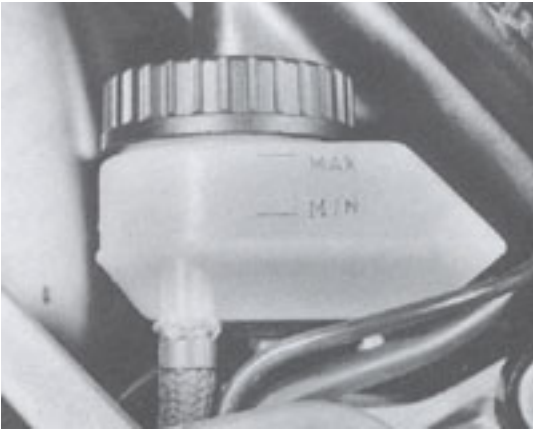

Brake hydraulic fluid level must be maintained above minimum level mark

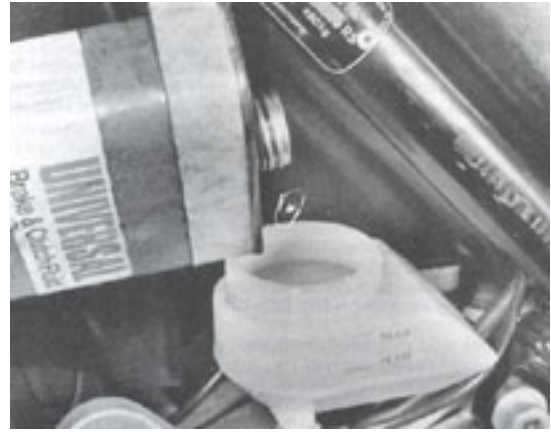

Use good quality fluid from a sealed container when topping up



Ensure diaphragm is clean and dry before refitting

Brake fluid renewal

Note that hydraulic brake fluid must be changed annually. It is necessary to renew the brake fluid at this interval to preserve maximum brake efficiency by ensuring that the fluid has not been contaminated and deteriorated to an unsafe degree.

Before starting work, obtain a new, full can of the specified hydraulic fluid and read carefully the Section on brake bleeding in Chapter 6. Prepare the clear plastic tube end glass jar in the same way as for bleeding the hydraulic system, open each bleed nipple by unscrewing it $1\frac{1}{4}$ - $1\frac{1}{2}$ turn with a spanner and apply the front brake lever or rear brake pedal (as applicable) gently and repeatedly. This will pump out the old fluid. **Keep the master cylinder reservoir topped up at all times**, otherwise air may enter the system and greatly lengthen the operation. The old brake fluid is invariably much darker in color than the new, making it easier to see when it is pumped out and the new fluid has completely replaced it. Note that the manufacturer recommends that in order to ensure the complete replacement of the old brake fluid, it will first be necessary to remove the brake pads and to push the caliper pistons back as far as possible into the caliper body. Where more than one bleed nipple is fitted to a system (eg the front brake) repeat the

operation on both nipples to ensure that the old fluid is completely removed. Top up the master cylinder when the operation is complete.

14. Check and overhaul the brakes

This operation is described in three sub-sections since while checking the fluid level and pads is within the scope of any owner, renewing is a different matter. Owners are advised to read the instructions to get some idea of what is involved and to then decide whether to attempt all or part of the work themselves, or whether to take the machine to a dealer.

DIAGNOSIS

Contents

Introduction	1
Starter motor problems	
Starter motor not rotating	2
Starter motor rotates but engine does not turn over	3
Starter motor and clutch function but engine will not turn over...	4
Engine does not start when turned over	
No fuel flow to engine	5
Fuel not reaching cylinder	6
Engine flooding	7
No spark at plug	8
Weak spark at plug	9
Compression low	10
Engine stalls after starting	
General causes	11
Poor running at idle and low speed	
Weak spark at plug or erratic firing	12
Fuel/air mixture incorrect	13
Compression low	14
Acceleration poor	
General causes	15
Poor running or lack of power at high speeds	
Weak spark at plug or erratic firing	16
Fuel/air mixture incorrect	17
Compression low	18
Knocking or pinking	
General causes	19
Overheating	
Firing incorrect	20
Fuel/air mixture incorrect	21
Lubrication inadequate	22
Miscellaneous causes	23

Clutch operating problems	
Clutch slip	24
Clutch drag	25
Gear selection problems	
Gear lever does not return	26
Gear selection difficult or impossible	27
Jumping out of gear	28
Overselection	29
Abnormal engine noise	
Knocking or pinking	30
Piston slap or rattling from cylinder	31
Valve noise or tapping from cylinder head	32
Other noises	33
Abnormal transmission noise	
Clutch noise	34
Transmission noise	35
Exhaust smokes excessively	
White/blue smoke (caused by oil burning)	36
Black smoke (caused by over-rich mixture)	37
Oil pressure indicator lamp goes on	
Engine lubrication system failure	38
Electrical system failure	39
Poor handling or road holding	
Directional instability	40
Steering bias to left or right	41
Handlebar vibrates or oscillates	42
Poor front fork performance	43
Front fork judder when braking	44
Poor rear suspension performance	45
Abnormal frame and suspension noise	
Front end noise	46
Rear suspension noise	47
Brake problems	
Brakes are spongy or ineffective - disk brakes	48
Brakes drag - disk brakes	49
Brake lever or pedal pulsates in operation - disk brakes	50
Disk brake noise	51
Brakes are spongy or ineffective - drum brakes	52
Brake drag - drum brakes	53

Brake lever or pedal pulsates in operation - drum brakes	54
Drum brake noise	55
Brake induced fork judder	56
Electrical problems	
Battery dead or weak	57
Battery overcharged	58
Total electrical failure	59
Circuit failure	60
Bulbs blowing repeatedly	61

Introduction

This page provides an easy reference-guide to the more common faults that are likely to afflict your machine. Obviously, the opportunities are almost limitless for faults to occur as a result of obscure failures, and to try and cover all eventualities would require to write a book or an complete internet-site. Successful fault diagnosis is not a mysterious 'black art' but the application of a bit of knowledge combined with a systematic and accurately approach to the problem. Approach any fault diagnosis by first accurately identifying the symptom and then checking through the list of possible causes, starting with the the simplest or most obvious and progressing in stages to the most complex. Take nothing for granted, but above all apply liberal quantities of common sense. The motorcycle is split up in different categories and the main symptom of a fault is given in the navigation bar on the left-side, by choosing your problem and click on it, you will go to the next page where the details of each possible cause for a fault and the remedial action to be taken are given in a brief way.

Starter motor problems

2 -- Starter motor not rotating.

- ▽ Engine stop switch off.
- ▽ Fuse blown. Check fuse number 1 located behind the left-hand side panel.
- ▽ Battery voltage low. Switching on the headlamp will give a good indication of the charge level. If necessary recharge the battery from an external source.
- ▽ Load-shedding relay faulty. If the ancillary circuits are not cut off when the starter motor is operating the current drain may be sufficient to prevent the motor from rotating. Renew the relay.
- ▽ Neutral gear not selected.
- ▽ Faulty neutral indicator switch or clutch interlock switch. Check the switch wiring and switches for correct operation.
- ▽ Ignition switch defective. Check switch for continuity and connections for security.
- ▽ Engine stop switch defective. Check switch for continuity in 'Run' position. Fault will be caused by broken, wet or corroded switch contacts. Clean or renew as necessary.
- ▽ Starter button switch faulty. Check continuity of switch. Fault as for engine stop switch.

- ▷ Starter relay faulty. If the switch is functioning correctly a pronounced click should be heard when the starter button is depressed. This presupposes that current is flowing to the solenoid when the button is depressed.
 - ▷ Wiring open or shorted. Check first that the battery terminal connections are tight and corrosion free. Follow this by checking that all wiring connections are dry, tight and corrosion free. Check also for frayed or broken wiring. Occasionally a wire may become trapped between two moving components, particularly in the vicinity of the steering head, leading to breakage of the internal core but leaving the softer but more resilient outer core intact. This can cause mysterious intermittent or total power loss.
 - ▷ Starter motor defective. A badly worn starter motor may cause high current drain from a battery without the motor rotating. If current is found to be reaching the motor, after checking the starter button and starter relay, suspect a damaged motor. The motor should be removed for inspection.
-

3 -- Starter motor rotates but engine does not turn over.

- ▷ Starter motor clutch defective. Suspect jammed or worn engagement rollers, plungers and springs (early 100 models) or locking sprags (all models). Note particularly that clutch may be rendered inoperable by build-up of oily sludge, in which case stripping and flushing out is required. Modified components may be available to effect a more permanent solution.
- ▷ Damaged starter motor drive train. Inspect and renew components where necessary. Failure in this area is unlikely.

4 -- Starter motor and clutch function but engine will not turn over.

- ▶ Engine seized. Seizure of the engine is always a result of damage to internal components due to lubrication failure, or component breakage resulting from abuse, neglect or old age. A seizing or partially seized component may go unnoticed until the engine has cooled down and an attempt is made to restart the engine. Suspect first seizure of the valves, valve gear and the pistons. Instantaneous seizure whilst the engine is running indicates component breakage. In either case major dismantling and inspection will be required.

Engine does not start when turned over

5 -- No fuel flow to engine

- ▽ No fuel or insufficient fuel in tank.
- ▽ Fuel pump faulty. Check first fuse number 6, located behind the left-hand side panel, then fuel injection relay before suspecting pump.
- ▽ Tank filler cap air vent obstructed. Usually caused by dirt or water. Clean the vent orifice.
- ▽ Fuel filter blocked. Blockage may be due to accumulation of rust or paint flakes from the tank's inner surface or of foreign matter from contaminated fuel. Renew the filter and clean the pump gauze strainer. Look also for water droplets in the fuel.
- ▽ Fuel line blocked. Blockage of the fuel line is more likely to result from a kink in the line rather than the accumulation of debris.

6 -- Fuel not reaching cylinder

- ▷ If fuel is present under pressure in the rail but not reaching the intake port then either the injector is blocked or faulty or there is a fault in the fuel or ignition system components. Take the machine to an authorized BMW dealer for testing.

7 -- Engine flooding

- ▷ Flooding of the engine itself can be caused only by dirt jamming an injector open. Renew the injector and clean out the fuel system.
- ▷ An excessively rich mixture can only be caused by a fault in the fuel injection control unit, although it is possible for a faulty temperature sensor to cause the control unit to carry on feeding a rich mixture to the engine when it is fully warmed up.

8 -- No spark at plug

- ▷ Ignition switch not on.
- ▷ Engine stop switch off.
- ▷ Fuse blown. Check fuse for ignition circuit. See wiring diagram.

- ▽ Battery voltage low. The current draw required by a starter motor is sufficiently high that an under-charged battery may not have enough spare capacity to provide power for the ignition circuit during starting.
- ▽ Load shedding relay faulty, causing same symptoms as above. Renew the relay.
- ▽ Starter motor inefficient. A starter motor with worn brushes and a worn or dirty commutator will draw excessive amounts of current causing power starvation in the ignition system. See the preceding paragraph. Starter motor overhaul will be required.
- ▽ Spark plug failure. Clean the spark plugs thoroughly and reset the electrode gaps. Refer to the spark plug section and the color condition guide in Routine Maintenance. If a spark plug shorts internally or has sustained visible damage to the electrodes, core or ceramic insulator it should be renewed. On rare occasions a plug that appears to spark vigorously will fail to do so when refitted in the cylinder.
- ▽ Spark plug cap or high tension (HT) lead faulty. Check condition and security. Replace if deterioration is evident.
- ▽ Spark plug cap loose. Check that the spark plug caps fit securely over the plug and, where fitted, the screwed terminal on the plug end are secure.
- ▽ Shorting due to moisture. Certain parts of the ignition system are susceptible to shorting when the machine is ridden or parked in wet weather. Check particularly the area from the spark plug cap back to the ignition coil. A water dispersant spray may be used to dry out waterlogged components. Recurrence of the problem can be prevented by using an ignition sealant spray after drying out and cleaning.
- ▽ Ignition or stop switch shorted. May be caused by water, corrosion or wear. Water dispersant and contact cleaning sprays may be used. If this fails to overcome the problem dismantling and visual inspection of the switches will be required.
- ▽ Shorting or open circuit in wiring. Failure in any wire connecting any of the ignition components will cause ignition malfunction. Check also all connections are clean, dry and tight.
- ▽ Ignition coil failure. Check the coil, referring to Chapter 6.

9 -- Weak spark at plug

- ▽ Feeble sparking at the plug may be caused by any of the faults mentioned in the preceding Section other than those items in paragraphs 1 to 3. Check first the spark plug, this being the most likely culprit.

10 -- Compression low

- ▽ Spark plug loose. This will be self-evident on inspection, and may be accompanied by a hissing noise when the engine is turned over. Remove the plugs and check that the threads in the cylinder head are not damaged. Check also that the plug sealing washers are in good condition.
- ▽ Cylinder head gasket leaking. This condition is often accompanied by a high pitched squeak from around the cylinder head and oil loss, and may be caused by insufficiently tightened cylinder head fasteners, a warped cylinder head or mechanical failure of the gasket material. Re-torquing the fasteners to the correct specification may seal the leak in some instances but if damage has occurred this course of action will provide, at best, only a temporary cure.
- ▽ Valve not seating correctly. The failure of a valve to seat may be caused by insufficient valve clearance, pitting of the valve seat or face, carbon deposits on the valve seat or seizure of the valve stem or valve gear components. Valve spring breakage will also prevent correct valve closure. The valve clearance should be checked first and then, if these are found to be in order, further dismantling will be required to inspect the relevant components for failure.

- ▷ Cylinder, piston and ring wear. Compression pressure will be lost if any of these components are badly worn. Wear in one component is invariably accompanied by wear in another. A top end overhaul will be required.

- ▷ Piston rings sticking or broken. Sticking of the piston rings may be caused by seizure due to lack of lubrication or heating as a result of poor carburation or incorrect fuel type. Gumming of the rings may result from lack of use, or carbon deposits in the grooves. Broken rings result from over-revving, overheating or general wear. In either case a top-end overhaul will be required.

Engine stalls after starting

11 -- General causes

- ▽ Fuel system fault. See Chapter 5.
- ▽ Ignition malfunction. See Section 9. 'Weak spark at plug'.
- ▽ Fuel contamination. Clean the filter and, where water is in evidence, drain and flush the fuel tank.
- ▽ Intake air leak. Check for security of the hose connections, and for cracks or splits in the hoses.
- ▽ Air filter blocked or omitted. A blocked filter will cause an over-rich mixture; the omission of a filter will cause an excessively weak mixture. Both conditions will affect the mixture ratio adversely. Clean or renew the filter as necessary.
- ▽ Fuel filler cap air vent blocked. Usually caused by dirt or water. Clean the vent orifice.

Poor running at idle and low speed

12 -- Weak spark at plug or erratic firing

- ▼ Battery voltage low. In certain conditions low battery charge, especially when coupled with a badly sulphated battery, may result in misfiring. If the battery is in good general condition it should be recharged; an old battery suffering from sulphated plates should be renewed.
- ▼ Spark plugs fouled, faulty or incorrectly adjusted. See Section 8 or refer to Routine maintenance.
- ▼ Spark plug caps or high tension leads shorting. Check the condition of both these items ensuring that they are in good condition and dry and that the caps are fitted correctly.
- ▼ Spark plug type incorrect. Fit plugs of correct type and heat range as given in Specifications. In certain conditions a plug of hotter or colder type may be required for normal running.
- ▼ Ignition timing incorrect. Check the ignition timing.
- ▼ Faulty ignition coil. Partial failure of the coil internal insulation will diminish the performance of the coil. No repair is possible, a new component must be fitted.
- ▼ Ignition system fault. Refer to Chapter 6.

13 -- Fuel/ air mixture incorrect

- ▷ Intake air leak. See Section 11.
- ▷ Mixture strength incorrect. Adjust idle mixture strength using airflow meter bypass screw.
Fuel system fault. Refer to Chapter 5.
- ▷ Air cleaner clogged or omitted. Clean or fit air cleaner element as necessary.
Check also that the element and air filter cover is correctly seated.
- ▷ Fuel tank air vent obstructed. Obstruction usually caused by dirt or water. Clean vent orifice.
- ▷ Valve clearance incorrect. Check, and if necessary, adjust, the clearances.

14 -- Compression low

- ▷ See Section 10.

Acceleration poor

15 -- General causes

- ▷ All items as for previous Section.
- ▷ Fuel system fault. Refer to Chapter 5, checking particularly the airflow meter and throttle butterfly assembly.
- ▷ Brakes binding. Usually caused by maladjustment or partial seizure of the operating mechanism due to poor maintenance. Check brake adjustment (where applicable). A bent wheel spindle or warped brake disc can produce similar symptoms.

Poor running or lack of power at high speeds

16 -- Weak spark at plug or erratic firing

- ▷ All items as for Section 12.
 - ▷ HT lead insulation failure. Insulation failure of an HT lead and spark plug cap due to old age or damage can cause shorting when the engine is driven hard. This condition may be less noticeable, or not noticeable at all at lower engine speeds.
-

17 -- Fuel/air mixture incorrect

- ▷ All items as for Section 13, with the exception of item 2.
-

18 -- Compression low See section 10

Knocking or pinking

19 -- General causes

- ▷ Carbon build-up in combustion chamber. After high mileage's have been covered a large accumulation of carbon may occur. This may glow red hot and cause premature ignition of the fuel/air mixture, in advance of normal firing by the spark plug. Cylinder head removal will be required to allow inspection and cleaning.
- ▷ Fuel incorrect. A low grade fuel, or one of poor quality may result in compression induced detonation of the fuel resulting in knocking and pinking noises. Old fuel can cause similar problems. A too highly leaded fuel will reduce detonation but will accelerate deposit formation in the combustion chamber and may lead to early pre-ignition as described in item 1. Refer to fuel recommendation given in Chapter 5.
- ▷ Spark plug heat range incorrect. Uncontrolled pre-ignition can result from the use of a spark plug the heat range of which is too hot.
Weak mixture. Overheating of the engine due to a weak mixture can result in pre-ignition occurring where it would not occur when engine temperature was within normal limits.

Overheating

20 -- Firing incorrect

- ▽ Spark plug fouled, defective or maladjusted. see Section 8.
 - ▽ Spark plug type incorrect. Refer to the Specifications and ensure that the correct plug type is fitted.
 - ▽ Incorrect ignition timing. Timing that is far too much advanced or timing far too much retarded will cause overheating. Check the ignition is correct.
-

21 -- Fuel/air mixture incorrect

- ▽ Idle speed mixture strength incorrect. Adjust airflow meter bypass.
- ▽ Air filter badly fitted or omitted. Check that the filter element is in place and that it and the air filter box cover are sealing correctly. Any leaks will cause a weak mixture.
- ▽ Induction air leaks. Check the security of the hose connections, and for cracks and splits in the hoses.

- ▷ Fuel level too low. See Section 6.
 - ▷ Fuel tank filter cap air vent obstructed. Clear blockage.
-

22 -- Lubrication inadequate

- ▷ Engine oil too low. Not only does the oil serve as a lubricant by preventing friction between moving components, but it also acts as a coolant. Check the oil level and replenish.
 - ▷ Engine oil overworked. The lubricating properties of oil are lost slowly during use as a result of changes resulting from heat and also contamination. Always change the oil at the recommended interval.
 - ▷ Engine oil of incorrect viscosity or poor quality. Always use the recommended viscosity and type of oil.
 - ▷ Oil filter and filter by-pass valve blocked. Renew filter.
-

23 -- Miscellaneous causes

- ▷ Radiator fins clogged, or other cooling system fault. Refer to Chapter 4.

Clutch operating problems

24 -- Clutch slip

- ▽ No clutch lever play. Adjust clutch according to the procedure in Routine Maintenance.
- ▽ Clutch plate worn or warped. Overhaul clutch assembly, replacing plate if necessary. See Chapter 2.
- ▽ Pressure or cover plates worn or warped. overhaul clutch assembly, replacing plates if necessary. See Chapter 2.
- ▽ Clutch spring broken or worn. An old or heat-damaged (from slipping clutch) spring should be replaced with a new one.
- ▽ Clutch inner cable snagging. Caused by a frayed cable or kinked outer cable. Replace the cable with a new one. Repair of a frayed cable is not advised.
- ▽ Clutch release mechanism defective. Worn or damaged parts in the clutch release mechanism could include the pushrod, thrust bearing or piston. Replace parts as necessary.
- ▽ Oil leaking on to clutch plate. Dismantle clutch (Chapter 2) renew clutch plate, wash off all traces of oil and trace source of leak. If the leak is from the engine, refer to Chapter 1, if from the gearbox, refer to Chapter 3.

25 -- Clutch drag

- ▷ Clutch lever play excessive. Adjust release mechanism. See Routine Maintenance.
- ▷ Clutch plates warped or damaged. This will cause a drag on the clutch, causing the machine to creep. Overhaul clutch assembly (Chapter 2).
- ▷ Clutch release mechanism defective. Worn or damaged release mechanism parts can stick and fail to provide leverage. Overhaul clutch release mechanism ([Chapter 2](#)).
- ▷ Engine output shaft not properly located. Endfloat will permit movement of the clutch housing which may cause clutch drag. See Chapter 1.
- ▷ Loose clutch housing nut. See above. Tighten as described in Chapter 2.

Gear selection problems

26 -- Gear lever does not return

- ▽ Weak or broken spring. Renew the spring.
 - ▽ Gearchange shaft bent or seized. Distortion of the gearchange shaft often occurs if the machine is dropped heavily on the gear lever. Provided that damage is not severe straightening of the shaft is permissible.
-

27 -- Gear selection difficult or impossible

- ▽ Clutch not disengaging fully. See Section 25.
- ▽ Gearchange shaft bent. This often occurs if the machine is dropped heavily on the gear lever. Straightening of the shaft is permissible if the damage is not too great. Gearchange arms or pins worn or damaged. Wear or breakage of any of these items may cause difficulty in selecting one or more gears. Overhaul the selector mechanism.
- ▽ Selector claw arm spring broken. Renew spring.

- ▽ Gearchange drum detent cam or plunger damage. Failure, rather than wear, of these items may jam the drum thereby preventing gearchanging. The damaged items must be renewed.
 - ▽ Selector forks bent or seized. This can be caused by dropping the machine heavily on the gearchange lever or as a result of lack of lubrication. Though rare, bending of a shaft can result from a missed gearchange or false selection at high speed.
 - ▽ Selector fork end and pin wear. Pronounced wear of these items and the grooves in the gearchange drum can lead to imprecise selection and, eventually, no selection. Renewal of the worn components will be required.
 - ▽ Structural failure. Failure of any one component of the selector rod and change mechanism will result in improper or fouled gear selection.
-

28 -- Jumping out of gear

- ▽ Detent plunger assembly worn or damaged. Wear of the plunger and the cam with which it locates and breakage of the detent spring can cause imprecise gear selection resulting in jumping out of gear. Renew the damaged components.
- ▽ Gear pinion dogs worn or damaged. Rounding off the dog edges and the mating recesses in adjacent pinion can lead to jumping out of gear when under load. The gears should be inspected and renewed. Attempting to reprofile the dogs is not recommended.
- ▽ Selector forks, gearchange drum and pinion grooves worn. Extreme wear of these interconnected items can occur after high mileages especially when lubrication has been neglected. The worn components must be renewed.
- ▽ Gear pinions, bushes and shafts worn. Renew the worn components.
- ▽ Bent gearchange shaft. Often caused by dropping the machine on the gear lever.

- ▷ Gear pinion tooth broken. Chipped teeth are unlikely to cause jumping out of gear once the gear has been selected fully; a tooth which is completely broken off, however, may cause problems in this respect and in any event will cause transmission noise.
-

29 -- Overselection

- ▷ Claw arm spring weak or broken. Renew the spring.
- ▷ Detent plunger worn or broken. Renew the damaged items.
- ▷ Detent roller arm spring worn or broken. Renew the spring.
- ▷ Selector claw arm ends worn. Repairs can be made by wending and reprofiling with a file.
- ▷ Selector limiter claw components worn or damaged. Renew the damaged items.

Abnormal engine noise

30 -- Knocking or pinking

- ▷ See Section 19.
-

31 -- Piston slap or rattling from cylinder

- ▷ Cylinder bore/piston clearance excessive. Resulting from wear or partial seizure. This condition can often be heard as a high, rapid tapping noise when the engine is under little or no load, particularly when power is just beginning to be applied. Either fit new pistons or renew the cylinder block.
- ▷ Connecting rod bent. This can be caused by over-revving, trying to start a very badly flooded engine (resulting in a hydraulic leak in the cylinder) or by earlier mechanical failure such as a dropped valve. Attempts at straightening a bent connecting rod from a high performance engine are not recommended. Careful inspection of the crankshaft should be made before renewing the damaged connecting rod.

- ▽ Gudgeon pin, piston boss bore or small-end bearing wear or seizure. Excess clearance or partial seizure between normal moving parts of these items can cause continuous or intermittent tapping noises. Rapid wear or seizure is caused by lubrication starvation resulting from an insufficient engine oil level or oilway blockage.
 - ▽ Piston rings worn, broken or sticking. Renew the rings after careful inspection of the piston and bore.
-

32 -- Valve noise or tapping from the cylinder head

- ▽ Valve clearance incorrect. Adjust the clearances with the engine cold.
 - ▽ Valve spring broken or weak. Renew the spring set.
 - ▽ Camshaft or cylinder head worn or damaged. The camshaft lobes are the most highly stressed of all components in the engine and are subject to high wear if lubrication becomes inadequate. The bearing surfaces on the camshaft and cylinder head are also sensitive to a lack of lubrication. Lubrication failure due to blocked oilways can occur, but neglect of oil changes and of topping-up is the usual cause.
 - ▽ Worn camshaft drive components. A rustling noise or light tapping can be emitted, by a worn cam chain or worn sprockets and chain. If uncorrected, subsequent cam chain breakage may cause extensive damage. The worn components must be renewed before wear becomes too far advanced.
-

33 -- Other noises

- ▷ Big-end bearing wear. A pronounced knock from within the crankcase which worsens rapidly is indicative of big-end bearing failure as a result of extreme normal wear or lubrication failure. Remedial action in the form of a bottom end overhaul should be taken; continuing to run the engine will lead to further damage including the possibility of connecting rod breakage.
- ▷ Main bearing failure. Extreme normal wear or failure of the main bearings is characteristically accompanied by a rumble from the crankcase and vibration felt through the frame and footrests. Renew the worn bearings and carry out a very careful examination of the crankshaft.
- ▷ Crankshaft excessively out of true. A bent crank may result from over-revving or damage from an upper cylinder component or gearbox failure. Damage can also result from dropping the machine on the right-hand side. Straightening of the crankshaft is not possible in normal circumstances; a replacement item should be fitted.
- ▷ Engine mounting loose. Tighten all the engine mounting nuts and bolts.
- ▷ Cylinder head gasket leaking. The noise most often associated with a leaking head gasket is a high pitched squeaking, although any other noise consistent with gas being forced out under pressure from a small orifice can also be emitted. Gasket leakage is often accompanied by oil seepage from around the mating joint or from the cylinder head holding down bolts and nuts. Leakage into the cam chain tunnel or oil return passages will increase crankcase pressure and may cause oil leakage at joints and oil seals. Also, oil contamination will be accelerated. Leakage results from insufficient or uneven tightening of the cylinder head fasteners, or from random mechanical failure. Retightening to the correct torque figure will, at best, only provide a temporary cure. The gasket should be renewed at the -earliest opportunity.
- ▷ Exhaust system leakage. Popping or crackling in the exhaust system, particularly when it occurs with the engine on the overrun, indicates a poor joint either at the cylinder port or at the exhaust pipe/silencer connection. Failure of the gasket or looseness of the clamp should be looked for.

Abnormal transmission noise

34 -- Clutch noise

- ▽ Clutch plate center splines worn. Renew the clutch plate and examine closely the gearbox-input shaft.
 - ▽ Loose clutch housing nut or cover plate bolts. Retighten securely. See Chapter 2.
-

35 -- Transmission noise

- ▽ Bearing or bushes worn or damaged. Renew the affected components.
- ▽ Gear pinions worn or chipped. Renew the gear pinions.
- ▽ Metal chips jammed in gear teeth. This can occur when pieces of metal from any failed component are picked up by a meshing pinion. The condition will lead to rapid bearing wear or early gear failure.
- ▽ Oil level too low. Top up immediately to prevent damage to gearbox.

▷ Gearchange mechanism worn or damaged. Wear or failure of certain items in the selection and change components can induce mis-selection of gears (see Section 27) where incipient engagement of more than one gear set is promoted. Remedial action, by the overhaul of the gearbox, should be taken without delay.

Exhaust smokes excessively

36 -- White/blue smoke (caused by oil burning)

- ▽ Cloud of smoke released upon starting, especially if machine has been parked on side stand or if engine is still warm. This appears to be a characteristic possessed by all K-series BMWs to a greater or lesser extent, but should reduce considerably as the pistons and rings bed in. Provided little or no oil is used, there is nothing that can be done about this, other than to use the center stand at all times. If oil consumption is significant, or increases suddenly, a full engine strip will be required to investigate the cause.
- ▽ Piston rings worn or broken. Breakage or wear of any ring, but particularly an oil control ring, will allow engine oil past the piston into the combustion chamber. Overhaul the cylinder block and pistons.
- ▽ Cylinder block cracked, worn or scored. These conditions may be caused by overheating, lack of lubrication, component failure or advanced normal wear. The cylinder block should be renewed.
- ▽ Valve oil seal damaged or worn. This can occur as a result of valve guide failure or old age. The emission of smoke is likely to occur when the throttle is closed rapidly after acceleration, for instance, when changing gear. Renew the valve oil seals and, if necessary, the valve guides.
- ▽ Valve guides worn. See the preceding paragraph.
- ▽ Engine oil level too high. This increases the crankcase pressure and allows oil to be forced past the piston rings. Often accompanied by see page of oil at joints and oil seals.

- ▷ Cylinder head gasket blown between cam chain tunnel or oil return passage. Renew the cylinder head gasket.
 - ▷ Abnormal crankcase pressure. This may be caused by blocked breather passages or hoses causing back-pressure at high engine revolutions.
-

37 -- Black smoke (caused by over-rich mixture)

- ▷ All items as for Section 7.

Oil pressure indicator lamp goes on

38 -- Engine lubrication system failure

- ▼ Engine oil defective. Oil pump shaft or locating pin sheared off from ingesting debris or seizing from lack of lubrication (low oil level).
- ▼ Engine oil screen clogged. Change oil and filter and service pickup screen. See Routine Maintenance and/or Chapter 5.
- ▼ Engine oil level too low. Inspect for leak or other problem causing low oil level and add recommended lubricant. See Routine Maintenance.
- ▼ Engine oil viscosity too low. Very old, thin oil, or an improper weight of oil used in engine. Change to correct lubricant.
- ▼ Camshaft or journals worn. High wear causing drop in oil pressure. Replace cam and/or head. Abnormal wear could be caused by oil starvation at high rpm from low oil level, improper oil weight or type.
- ▼ Crankshaft and/or bearings worn. Same problems as paragraph 5. Overhaul lower end (Chapter 1).
- ▼ Relief valve stuck open. This causes the oil to be dumped back into the sump. Repair or replace. (See Chapter 5).

39 -- Electrical system failure

- ▶ Oil pressure switch defective. Check switch according to the procedures in Chapter 10. Replace if defective.
- ▶ Oil pressure indicator lamp wiring system defective. Check for pinched, shorted, disconnected or damaged wiring (Chapter 10).

Poor handling or road holding

40 -- Directional instability

- ▽ Steering head bearing adjustment too tight. This will cause rolling or weaving at low speeds. Re-adjust the bearings.
- ▽ Steering head bearings worn or damaged. Correct adjustment of the bearing will prove impossible to achieve if wear or damage has occurred. Inconsistent handling will occur including rolling or weaving at low speed and poor directional control at indeterminate higher speeds. The steering head bearing should be dismantled for inspection and renewed if required. Lubrication should also be carried out.
- ▽ Bearing races pitted or dented. Impact damage caused, perhaps, by an accident or riding over a pothole can cause indentation of the bearing, usually in one position. This should be noted as notchiness when the handlebars are turned. Renew and lubricate the bearings.
- ▽ Steering stem bent. This will occur only if the machine is subjected to a high impact such as hitting a curb or a pothole. The lower yoke/stem should be renewed; do not attempt to straighten the stem.
- ▽ Front or rear tire pressures too low.

- ▷ Front or rear tire worn. General instability, high speed wobbles and skipping over white lines indicates that tire renewal may be required. Tire induced problems, in some machine/tire combinations, can occur even when the tire in question is by no means fully worn.
 - ▷ Swinging arm bearings worn. Difficulty in holding line, particularly when cornering or when changing power settings indicates wear in the swinging arm bearings. The swinging arm should be removed from the machine and the bearings renewed if adjustment does not cure the fault.
 - ▷ Swinging arm flexing. The symptoms given in the preceding paragraph will also occur if the swinging arm fork flexes badly. This can be caused by structural weakness as a result of corrosion, fatigue or impact damage.
 - ▷ Wheel bearings worn. Renew the worn bearings.
 - ▷ Tires unsuitable for machine. Not all available tires will suit the characteristics of the frame and suspension, indeed, some tires or tire combinations may cause a transformation in the handling characteristics. If handling problems occur immediately after changing to a new tire type or make, revert to the original tires to see whether an improvement can be noted. In some instances a change to what are, in fact, suitable tyres may give rise to handling deficiencies. In this case a thorough check should be made of all frame and suspension items which affect stability.
-

41 -- Steering bias to left or right

- ▷ Wheels out of alignment. This can be caused by impact damage to the frame, swinging arm, wheel spindle or front forks. Although occasionally a result of material failure or corrosion it is usually as a result of a crash.

- ▽ Front forks twisted in the fork yokes. A light impact, for instance with a pothole or low curb, can twist the fork legs in the yokes without causing structural damage to the fork legs or the yokes themselves. Re-alignment can be made by loosening the yoke pinch bolts, wheel spindle and mudguard bolts. Re-align the wheel with the handlebars and tighten the bolts working upwards from the wheel spindle. This action should be carried out only when there is no chance that structural damage has occurred.
-

42 -- Handlebar vibrates or oscillates

- ▽ Tires worn or out of balance. Either condition, particularly in the front tire, will promote shaking of the fork assembly and thus the handlebars. A sudden onset of shaking can result if a balance weight is displaced during use.
- ▽ Tires badly positioned on the wheel rims. A moulded line on each wall of a tire is provided to allow visual verification that the tire is correctly positioned on the rim. A check can be made by rotating the tire; any misalignment will be immediately obvious.
- ▽ Wheel rims warped or damaged. Inspect the wheels for run out as described in Routine Maintenance.
- ▽ Swinging arm bearings worn. Renew the bearings.
- ▽ Wheel bearings worn. Renew the bearings.
- ▽ Steering head bearings incorrectly adjusted. Vibration is more likely to result from bearings which are too loose rather than too tight. Re-adjust the bearings.

- ▷ Loose fork component fasteners. Loose nuts and bolts holding the fork legs, wheel spindle, mudguards or steering stem can promote shaking at the handlebars. Fasteners on running gear such as the forks and suspension should be checked and tightened occasionally to prevent dangerous looseness of components occurring.
Engine mounting bolts loose. Tighten all fasteners.
-

43 -- Poor front fork performance

- ▷ Damping fluid level incorrect. If the fluid level is too low poor suspension control will occur resulting in a general impairment of road holding and early loss of tire adhesion when cornering and braking. Too much oil is unlikely to change the fork characteristics unless severe overfilling occurs when the fork action will become stiffer and oil seal failure may occur.
- ▷ Damping oil viscosity incorrect. The damping action of the fork is directly related to the viscosity of the damping oil. The lighter the oil used, the less will be the damping action imparted. For general use, use the recommended type of oil, changing to a slightly higher or heavier oil only when a change in damping characteristic is required. Overworked oil, or oil contaminated with water which has found its way past the seals, should be renewed to restore the correct damping performance and to prevent bottoming of the forks.
- ▷ Damping components worn or corroded. Advanced normal wear of the fork internals is unlikely to occur until a very high mileage has been covered. Continual use of the machine with damaged oil seals which allows the ingress of water, or neglect, will lead to rapid corrosion and wear. Dismantle the forks for inspection and overhaul. See Chapter 7.
- ▷ Weak fork springs. Progressive fatigue of the fork springs, resulting in a reduced spring free length, will occur after extensive use. This condition will promote excessive fork dive under braking, and in its advanced form will reduce the at-rest extended length of the forks and thus the fork geometry. Renewal of the springs as a pair is the only satisfactory course of action.

- ▷ Bent stanchions or corroded stanchions. Both conditions will prevent correct telescoping of the fork legs, and in an advanced state can cause sticking of the fork in one position. In a mild form corrosion will cause stiction of the fork thereby increasing the time the suspension takes to react to an uneven road surface. Bent fork stanchions should be attended to immediately because they indicate that impact damage has occurred, and there is a danger that the forks will fail with disastrous consequences.
-

44 -- Front fork judder when braking (see also Section 56)

- ▷ Wear between the fork stanchions and the fork legs. Renewal of the affected components is required.
 - ▷ Slack steering head bearings. Re-adjust the bearings.
 - ▷ Warped brake disc. If irregular braking action occurs fork judder can be induced in what are normally serviceable forks. Renew the damaged brake components.
-

45 -- Poor rear suspension performance

- ▷ Rear suspension unit damper worn out or leaking. The damping performance of most rear suspension units fails off with age. This is a gradual process, and thus may not be immediately obvious. Indications of poor damping include hopping of the rear end when cornering or braking, and a general loss of positive stability. See Chapter 8.

- ▷ Weak rear spring. If the suspension unit spring fatigues it will promote excessive pitching of the machine and reduce the ground clearance when cornering.
- ▷ Swinging arm flexing or bearings worn. See Section 40 and Section 41.
- ▷ Bent suspension unit damper rod. This is likely to occur only if the machine is dropped or if seizure of the piston occurs.

Abnormal frame and suspension noise

46 --Front end noise

- ▷ Oil level low or too thin. This can cause a 'spurting' sound and is usually accompanied by irregular fork action.
 - ▷ Spring weak or broken. Makes a clicking or scraping sound. Fork oil will have a lot of metal particles in it.
 - ▷ Steering head bearings loose or damaged. Clicks when braking. Check, adjust or replace.
 - ▷ Fork yokes loose. Make sure all fork yoke pinch bolts are tight.
 - ▷ Fork stanchion bent. Good possibility if machine has been dropped. Repair or replace tube.
-

47 -- Rear suspension noise

- ▷ Fluid level too low. Leakage of a suspension unit, usually evident by oil on the outer surface, can cause a spurting noise. The suspension unit should be renewed.
- ▷ Defective rear suspension unit with internal damage. Renew the suspension unit.

Brake problems

48 -- Brakes are spongy or ineffective - disc brakes

- ▼ Air in brake circuit. This is only likely to happen in service due to neglect in checking the fluid level or because a leak has developed. The problem should be identified and the brake system bled of air.
- ▼ Pad worn. Check the pad wear and renew the pads if necessary.
- ▼ Contaminated pads. Cleaning pads which have been contaminated with oil, grease or brake fluid is unlikely to prove successful; the pads should be renewed.
- ▼ Pads glazed. This is usually caused by overheating. The surface of the pads may be roughened using glass-paper or a fine file.
- ▼ Brake fluid deterioration. A brake which on initial operation is firm but rapidly becomes spongy in use may be failing due to water contamination of the fluid. The fluid should be drained and then the system refilled and bled.
- ▼ Master cylinder seal failure. Wear or damage of master cylinder internal parts will prevent pressurization of the brake fluid. Overhaul the master cylinder unit.

- ▽ Caliper seal failure. This will almost certainly be obvious by loss of fluid, a lowering of fluid in the master cylinder reservoir and contamination of the brake pads and caliper. Overhaul the caliper assembly.
 - ▽ Brake pedal improperly adjusted. Adjust the clearance between the pedal and master cylinder to take up lost motion, as recommended in Chapter 9.
-

49 -- Brakes drag - disc brakes

- ▽ Disc warped. The disc must be renewed.
- ▽ Caliper piston, caliper or pads corroded. The brake caliper assembly is vulnerable to corrosion due to water and dirt, and unless cleaned at regular intervals and lubricated in the recommended manner, will become sticky in operation.
- ▽ Piston seal deteriorated. The seal is designed to return the piston in the caliper to the retracted position when the brake is released. Wear or old age can affect this function. The caliper should be overhauled if this occurs.
- ▽ Brake pad damaged. Pad material separating from the backing plate due to wear - or faulty manufacture. Renew the pads. Faulty installation of a pad also will cause dragging.
- ▽ Wheel spindle bent. The spindle may be straightened if no structural damage has occurred.
- ▽ Brake lever or pedal not returning. Check that the lever or pedal works smoothly throughout its operating range and does not snag on any adjacent cycle parts. Lubricate the pivot if necessary.
- ▽ Twisted caliper support bracket. This is likely to occur only after impact in an accident. Renew the caliper assembly.

50 -- Brake lever or pedal pulsates in operation - disc brakes

- ▷ Disc warped or irregularly worn. The disc must be renewed.
 - ▷ Wheel spindle bent. The spindle may be straightened provided no structural damage has occurred.
-

51 -- Disc brake noise

- ▷ Brake squeal. Squealing can be caused by dust on the pads, usually in combination with glazed pads, or other contamination from oil, grease, brake fluid or corrosion. Persistent squealing which cannot be traced to any of the normal causes can often be cured by applying a thin layer of high temperature silicone grease to the rear of the pads. Make absolutely certain that no grease is allowed to contaminate the braking surface of the pads.
- ▷ Glazed pads. This is usually caused by high temperatures or contamination. The pad surfaces may be roughened using glass-paper or a fine file. If this approach does not effect a cure the pads should be renewed.
- ▷ Pad material incompatible. BMW state that some non-genuine brake pads are made of poor quality friction materials which cause excessive squeal; these should be avoided.
- ▷ Pad material. Friction material designed to cope with extreme temperatures may squeal at lower speeds, in town use.

- ▷ Disc warped. This can cause a chattering, clicking or intermittent squeal and is usually accompanied by a pulsating brake lever or pedal or uneven braking. The disc must be renewed.
 - ▷ Brake pads fitted incorrectly. Inspect the pads for correct installation and security.
-

52 -- Brakes are spongy or ineffective - drum brakes

- ▷ Worn brake linings. Determine lining wear using the external brake wear indicator on the brake back plate, or by removing the wheel and withdrawing the brake back plate. Renew the shoes as a pair if the linings are worn below the minimum thickness.
- ▷ Worn brake camshaft. Wear between the camshaft and the bearing surface will reduce brake feel and reduce operating efficiency. Renewal of one or both items will be required to rectify the fault.
- ▷ Worn brake cam and shoe ends. Renew the worn components.
- ▷ Linings contaminated with dust or grease. Any accumulations of dust should be cleaned from the brake assembly and drum using a petrol dampened cloth. Do not blow or brush off the dust because it is asbestos based and thus harmful if inhaled. Light contamination from grease can be removed from the surface of the brake linings using a solvent; attempts at removing heavier contamination are less likely to be successful because some of the lubricant will have been absorbed by the lining material which will severely reduce the braking performance.
- ▷ Brake components not centralized on wheel. See Chapter 9.
- ▷ Angle between operating lever and brake rod incorrect. See Routine Maintenance.

53 -- Brake drag - drum brakes

- ▷ Incorrect adjustment. Re-adjust the brake operating mechanism.
- ▷ Drum warped or oval. This can result from overheating or impact. The condition is difficult to correct, although if slight ovality only occurs, skimming the surface of the brake drum can provide a cure. This is work for a specialist engineer. Renewal of the complete wheel is normally the only satisfactory solution.
- ▷ Weak brake shoe return springs. This will prevent the brake shoes from pulling away from the drum surface once the brake is released. The springs should be renewed.
- ▷ Brake camshaft, lever pivot or cable poorly lubricated. Failure to attend to regular lubrication of these areas will increase operating resistance which, when compounded, may cause tardy operation and poor release movement.

54 -- Brake pedal pulsates in operation - drum brakes

- ▷ Drum warped or oval. This can result from overheating or impact. This condition is difficult to correct, although if slight ovality only occurs skimming the surface of the drum can provide a cure. This is work for a specialist engineer. Renewal of the wheel is normally the only satisfactory solution.

55 -- Drum brake noise

- ▷ Drum warped or oval. This can cause intermittent rubbing of the brake linings against the drum. See the preceding Section.
- ▷ Brake linings glazed. This condition, usually accompanied by heavy lining dust contamination, often induces brake squeal. The surface of the linings may be roughened using glass-paper or a fine file.
- ▷ Return springs vibrating. See Chapter 9.

56 -- Brake induced fork judder

- ▷ Worn front fork stanchions and legs, or worn or badly adjusted steering head bearings. These conditions, combined with uneven or pulsating braking as described in Section 50 will induce more or less judder when the brakes are applied, dependent on the degree of wear and poor brake operation. Attention should be given to both areas of malfunction. See the relevant Section.

Electrical problems

57 -- Battery dead or weak

- ▷ Battery faulty. Battery life should not be expected to exceed 3 to 4 years, particularly where a starter motor is used regularly. Gradual sulphation of the plates and sediment deposits will reduce the battery performance. Plate and insulator damage can often occur as a result of vibration. Complete power failure, or intermittent failure, may be due to a broken battery terminal. Lack of electrolyte will prevent the battery maintaining charge.
 - ▷ Battery leads making poor contact. Remove the battery leads and clean them and the terminals, removing all traces of corrosion and tarnish. Reconnect the leads and apply a coating of petroleum jelly to the terminals.
 - ▷ Load excessive. If additional items such as spot lamps, are fitted, which increase the total electrical load above the maximum alternator output, the battery will fail to maintain full charge. Reduce the electrical load to suit the electrical capacity.
 - ▷ Alternator failure.
-

58 -- Battery overcharged

- ▽ Alternator faulty. Overcharging is indicated if the battery becomes hot or it is noticed that the electrolyte level falls repeatedly between checks. In extreme cases the battery will boil causing corrosive gases and electrolyte to be emitted through the vent pipes.
 - ▽ Battery wrongly matched to the electrical circuit. Ensure that the specified battery is fitted to the machine.
-

59 -- Total electrical failure

- ▽ Fuse blown. Check the main fuse. If a fault has occurred, it must be rectified before a new fuse is fitted.
 - ▽ Battery faulty. See Section 57.
 - ▽ Earth failure. Check that the frame main earth strap from the battery is securely affixed to the frame and is making a good contact.
 - ▽ Ignition switch or power circuit failure. Check for current flow through the battery positive lead to the ignition switch. Check the ignition switch for continuity.
-

60 -- Circuit failure

- ▷ Cable failure. Refer to the machine's wiring diagram and check the circuit for continuity. Open circuits are a result of loose or corroded connections, either at terminals or in-line connectors, or because of broken wires. Occasionally, the core of a wire will break without there being any apparent damage to the outer plastic cover.
 - ▷ Switch failure. All switches may be checked for continuity in each switch position, after referring to the switch position boxes incorporated in the wiring diagram for the machine. Switch failure may be a result of mechanical breakage, corrosion or water.
 - ▷ Fuse blown. Refer to the wiring diagram to check whether or not a circuit fuse is fitted. Replace the fuse, if blown, only after the fault has been identified and rectified.
-

61 -- Bulbs blowing repeatedly

- ▷ Vibration failure. This is often an inherent fault related to the natural vibration characteristics of the engine and frame and is, thus, difficult to resolve. Modifications of the lamp mounting, to change the damping characteristics may help.
- ▷ Intermittent earth. Repeated failure of one bulb, particularly where the bulb is fed directly from the generator, indicates that a poor earth exists somewhere in the circuit. Check that a good contact is available at each earthing point in the circuit.
- ▷ Reduced voltage. Where a quartz-halogen bulb is fitted the voltage to the bulb should be maintained or early failure of the bulb will occur. Do not overload the system with additional electrical equipment in excess of the system's power capacity and ensure that all circuit connections are maintained clean and tight.

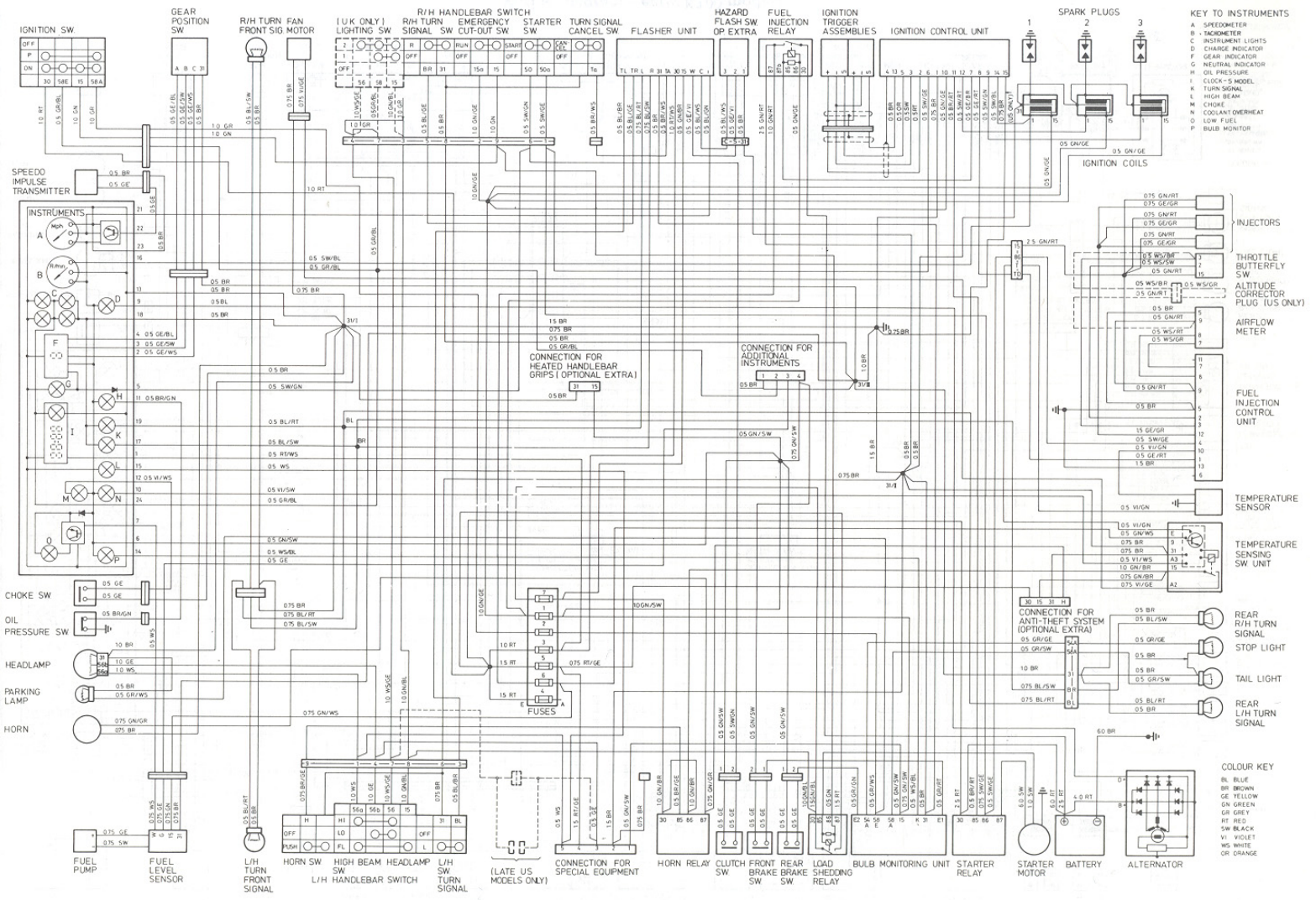

Wiring diagram - 75 models

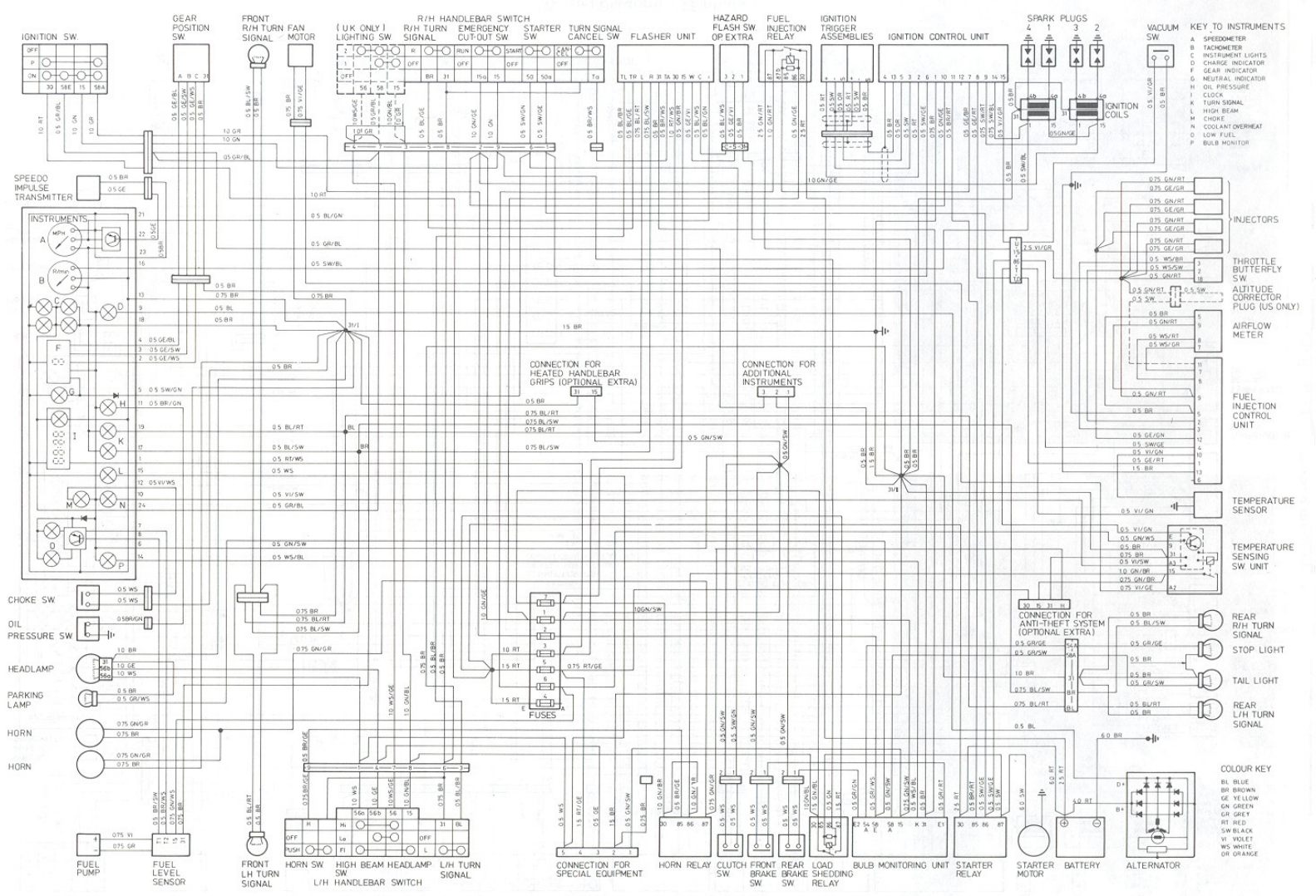

Wiring diagram – early K100 models

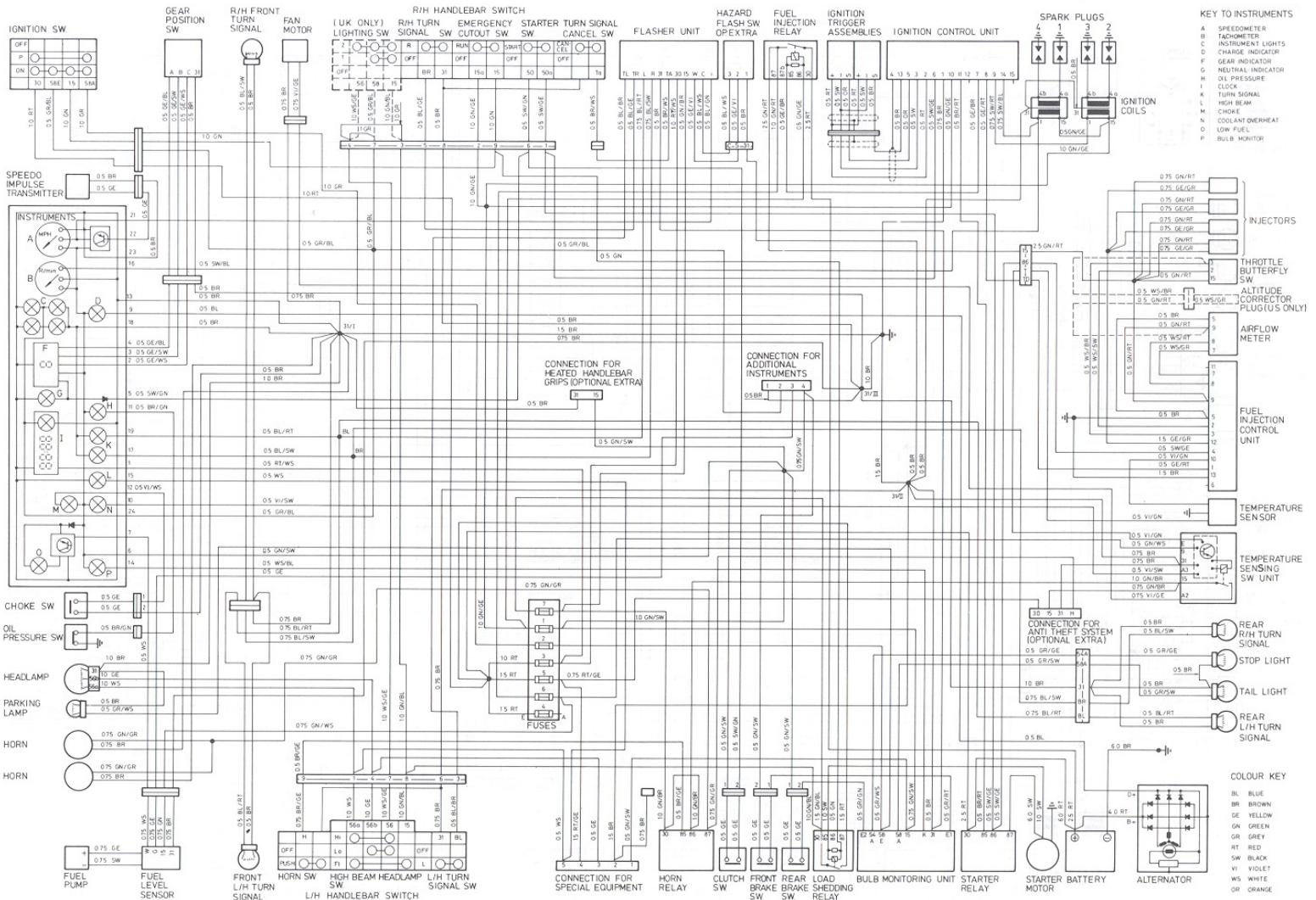

Wiring diagram – late K100 models

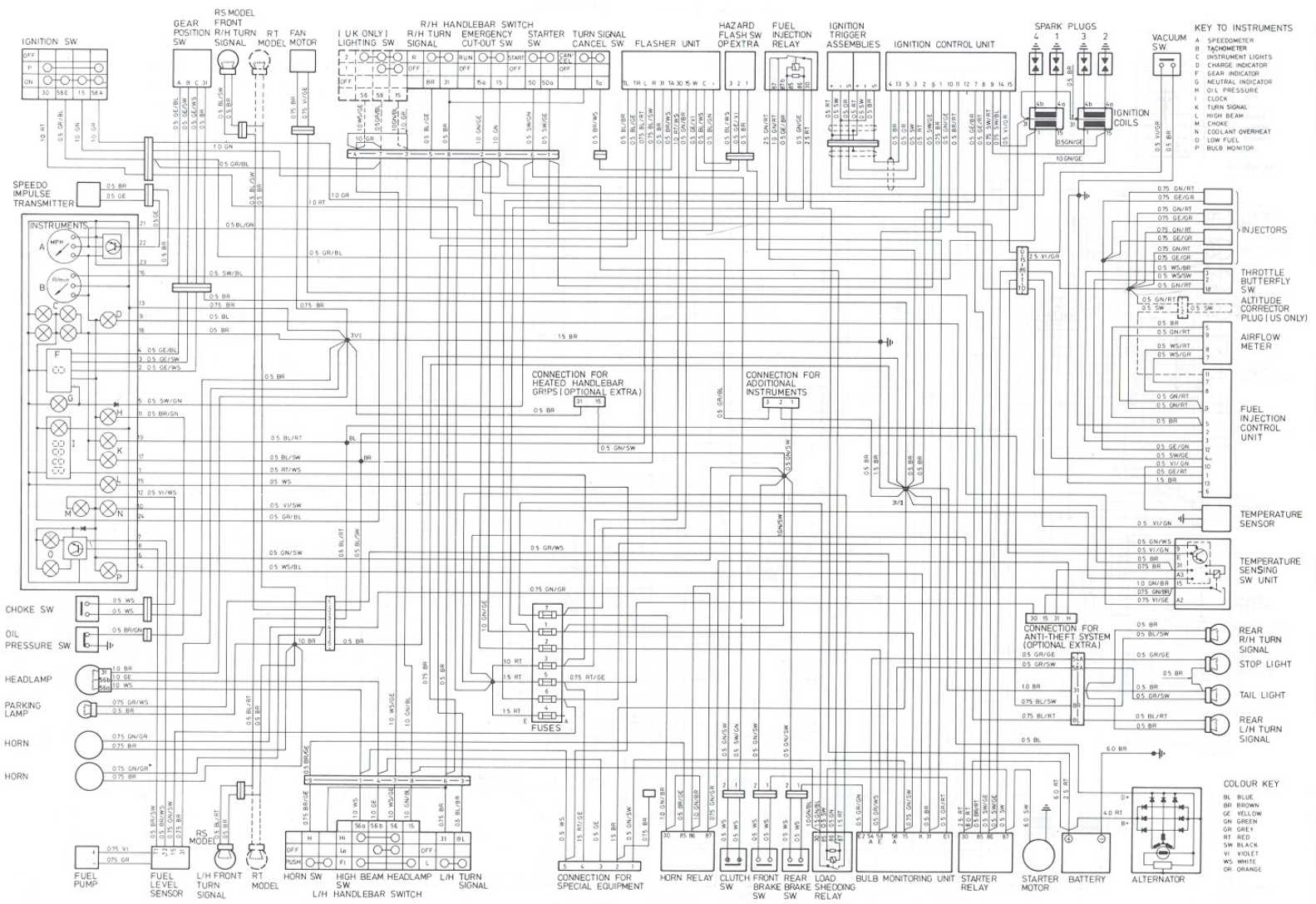

Wiring diagram – early K100 RS and RT models

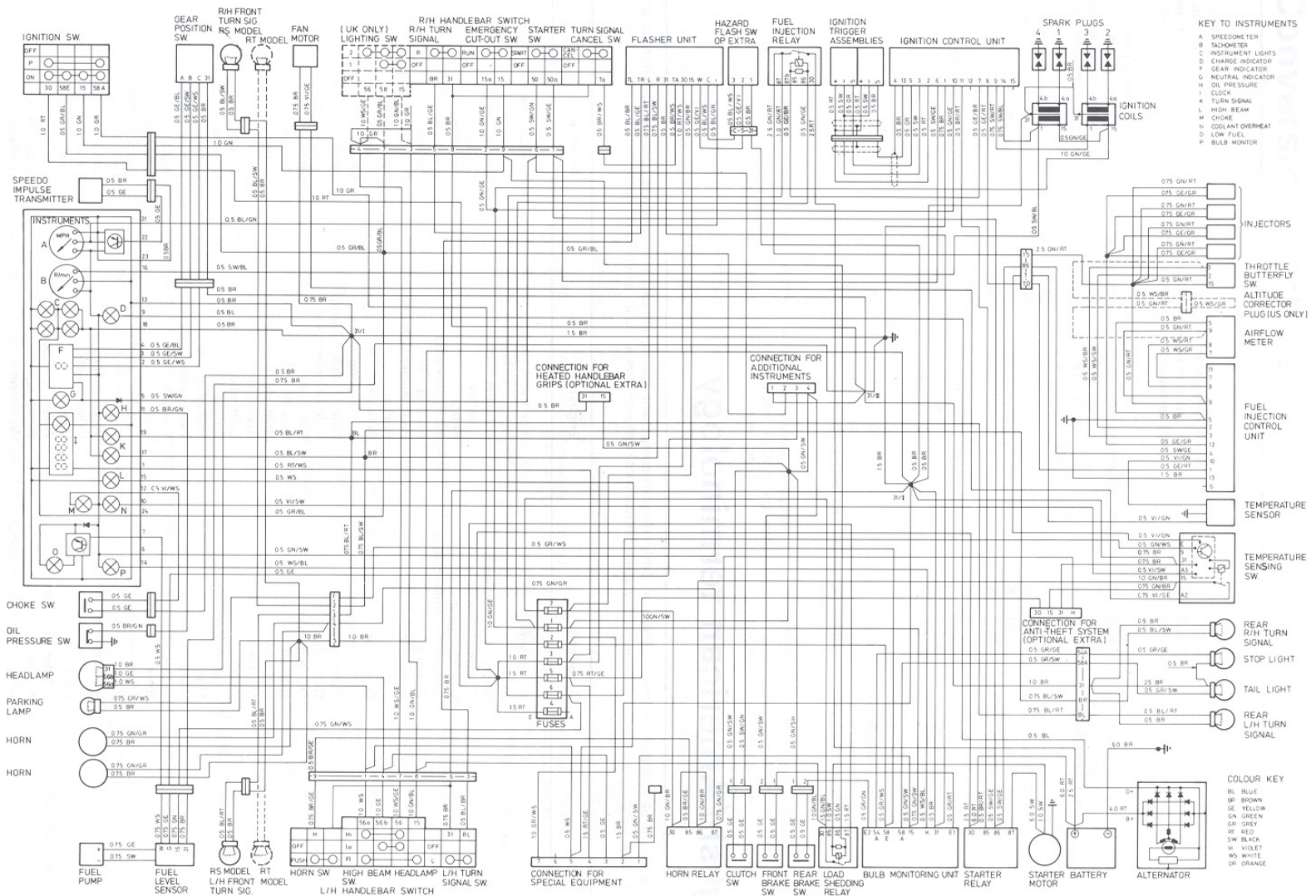

Wiring diagram – late K100 RS and RT models

- KEY TO INSTRUMENTS
- A SPEEDOMETER
 - B TACHOMETER
 - C INSTRUMENT LIGHTS
 - D CHARGE INDICATOR
 - F GEAR INDICATOR
 - G NEUTRAL INDICATOR
 - H OIL PRESSURE
 - I CLOCK
 - K TURN SIGNAL
 - L HIGH BEAM
 - M CHROME
 - N COOLANT OVERHEAT
 - O LOW FUEL
 - P BULB MONITOR

- COLOR KEY
- BL BLUE
 - BR BROWN
 - GE YELLOW
 - GN GREEN
 - GR GREY
 - HR RED
 - SW BLACK
 - VI VIOLET
 - WS WHITE
 - GR GRANGE

Chapter 1: Engine

2. Carrying out a compression test

1. A good idea of the internal state of the engine can be gained by testing its compression as follows.
2. The engine must be fully warmed up to normal operating temperature and the battery fully charged for the test results to be accurate.
3. Remove all the spark plugs. Noting the warnings concerning servicing the ignition system given in [Chapter 6](#), lay the spark plugs on the cylinder head so that their metal bodies are securely earthed to the metal of the cylinder head (to prevent damage to the ignition system) and so that their electrodes are well clear of the spark plug orifices (to prevent the risk of sparks igniting any fuel/air mixture that is ejected). While one cylinder is being tested, place a wad of rag over each of the remaining spark plug apertures as additional protection.
4. Attach an accurate, good quality compression gauge (tester) to the cylinder head spark plug orifice, following its manufacturer's instructions. Open the throttle fully. Spin the engine over on the starter motor and note the readings recorded.
5. After one or two revolutions the pressure should build up to a maximum figure and then stabilize; note the reading and repeat the test on the remaining cylinders. There should be no discernible difference between any readings. The expected pressures are given in Specifications. If all pressures are the same and in the good or normal range then the engine is in good condition.
6. If there is a marked discrepancy between the readings, or if any is in the poor range, the appropriate cylinder must be checked carefully.
7. Note that during a normal compression test one would go on to temporarily seal the piston rings by pouring a quantity of oil into the barrel and then take a second set of readings. If the pressure increased noticeably it could then be assumed that the piston rings were worn rather than the valves. Since it would be very difficult to get a full seal from such a method in a warm flat-cylinder engine there is little point in doing this; check the pistons and rings as well as the head gasket and valves when looking for the cause of compression loss.

Chapter 1: Engine

3. Dismantling the engine unit: general

1. The engine unit is so designed that the only parts of it which cannot be removed easily while the main crankcase/cylinder block casting is in the frame are the auxiliary drive shaft, including the starter idler shaft and starter clutch, and the output/balancer shaft assemblies. If the bellhousing or the crankcase lower section are to be removed to reach any of these components, the gearbox and final drive must be removed first ([see Chapter 3](#)) so that the clutch can be withdrawn ([see Chapter 2](#)) to give access to the bellhousing. The engine and frame will require very careful supporting if this procedure is adopted. See Section 7.
2. All other components can be removed with the main crankcase/cylinder block casting and the bellhousing still in the frame. Usually, components can be easily removed leaving others intact. For example, to remove the crankshaft it is possible merely to drain the coolant, to remove the engine left-hand, right-hand and front engine covers and to disconnect the cam chain before removing the big-end and main bearing caps and withdrawing the crankshaft.
3. K75 model owners should note, however, that it is necessary on reassembly to align timing marks on the crankshaft and balancer shaft gears. Since these marks may not be easily visible from the crankshaft opening it is recommended that this task be undertaken only with the engine unit removed. The amount of preliminary dismantling necessary to remove the balancer shaft with the engine in the frame means that there is in practice very little extra work to remove the entire unit and gain much improved working conditions.
4. Owners of all models should note that if a major overhaul is to be undertaken, or if more than one component requires attention at anytime, the engine unit should be removed from the frame. This is a basically simple procedure which permits excellent access to all components and allows the major castings to be cleaned so that the high standards required for successful rebuilding are maintained.
5. While notes on alternative procedures are provided where necessary, this Chapter is based on the assumption that the engine/transmission unit is to be removed from

Chapter 1: Engine

4. Removing the engine unit from the frame

Note: It is possible to separate the engine unit from the transmission at the bellhousing rear face and to remove the engine unit after the gearbox and final drive have first been withdrawn. (The engine cannot be removed on its own, leaving the gearbox and transmission attached to the frame, since this leads to an unacceptable risk of damage and a great deal of difficulty in aligning the clutch and gearbox input shaft and the engine mountings.) Since, however, the above method involves a great deal of care in aligning the gearbox input shaft and clutch release with the clutch and in supporting solidly the frame, engine and transmission components as they are separated, it is recommended that the engine and transmission are removed from the frame as a single unit and then separated,- the following instructions are based on this procedure. Owners who do not wish to use the recommended method should note that procedures are similar until the final stages. Refer to [Chapter 3](#) for more information.

1. Place the machine firmly on its center stand so that it is standing securely and there is no likelihood that it may fail over. This is extremely important as owing to the weight of the complete machine and the engine, any instability during dismantling will probably be uncontrollable. If possible, place the machine on a raised platform. This will improve accessibility and ease engine removal. Again, owing to the weight of the machine, ensure that the platform is sufficiently strong and well supported.
2. Drain the engine oil and remove the oil filter, as described in [Routine Maintenance](#).
3. On KI00 RS, KI00RT and KI00LT models it should suffice to remove only the fairing knee pads and lower sections (side panels and radiator cover); owners may, however, feel it preferable to eliminate any risk of damage by removing the entire fairing. On K75 S models it is best to remove the fairing. Where fitted, remove also the engine spoiler or belly fairing. Refer to [Chapter 7](#).
4. On all models, lift the seat, remove both side panels, remove the radiator cover panels (where fitted), then remove the fuel tank as described in [Chapter 5](#).

5. Note that whenever any component is moved, all mounting nuts, bolts, or screws should be refitted in their original locations with their respective washers and mounting rubbers and/or spacers.
6. Disconnect and remove the fuel injection control unit and storage tray, as described in [Chapter 5](#).
7. Remove the battery as described in Routine Maintenance and tie the coolant expansion tank to the frame out of harm's way.
8. Remove the air intake hose.
9. Working as described in [Chapter 4](#), drain the coolant, disconnect the radiator hoses (pull the bottom hose out of the crankcase cover) and remove the radiator.
10. Remove the exhaust system. See [Chapter 5](#).
11. Remove the alternator cover, ignition HT coil cover, number plate bracket and the rear mudguard.
12. Working as described in Routine Maintenance, disconnect and remove clear of the engine/transmission the throttle, choke and clutch cables.
13. Working methodically round the machine, disconnect all electrical wires joining the engine/transmission unit to the frame. Trace each wire from the component concerned up to the connector joining it to the main wiring loom and separate the connector; noting where each is installed. Remove the clamps or cable ties securing the wire to the frame. These wires include the alternator connector plug, the starter motor cable, the ignition HT coil low-tension wires (make a written note of exactly what color wire is fitted to which terminal), the frame earth connection (retained by a single nut and bolt to the left-hand side of the frame top tubes, at the rear of the steering head), the speedometer impulse transmitter, the stop lamp rear switch, the gear position indicator switch, the oil pressure switch, the ignition trigger assembly, the choke warning lamp switch and the engine wiring harness. Be very careful to check that all wires are released and are positioned so that they will not hinder the removal of the frame from the engine/transmission unit.
14. Slacken the two engine front mounting nuts and the bolts securing the bellhousing/frame joint and the two gearbox/frame joints; also the rear suspension bottom mounting nut. If any fastener is difficult to move, apply a good quantity of penetrating fluid and allow time for it to work before proceeding further. In the case of the front mounting bolts, slacken the nuts and attempt to break the bolts free by rotating them before attempting to tap them out. Make a final check that all components have been disconnected or removed which might hinder the removal of the frame from the engine/transmission unit; the unit should now be held only by its six mountings.
15. Enlist the aid of two or three assistants to withdraw the frame; one to 'steer' the front forks, another to lift the back of the frame and a third to help with the engine/transmission unit.
16. Place blocks of wood or similar under the sump so that the engine is securely supported and cannot fall. Place another block of wood or similar support under the final drive case; the support should be tall enough to fit closely under the casing.
17. Remove the rear suspension unit from its bottom mounting and lower the final drive

case on to its support; **do not** allow the swinging arm to move too far downwards or the gaiter at its front end may be torn and **never** allow it to drop or it may crack the casing.

18. With the assistants standing ready, unscrew and remove the bellhousing mounting bolt, the engine front mountings and the gearbox mounting bolts; note carefully the presence and number of any shims that may be found at any of the mountings. The engine/transmission unit should now be supported securely on its sump support, on the center stand and on the rear wheel/final drive support.
19. Taking care not to scratch the paintwork or damage any component, carefully lift the frame at the rear and walk it forwards clear of the engine and transmission.
20. On KI00 RS, KI00RT and KI00LT models check the engine front mounting rubber bushes for cracks, splits, perishing or compaction and renew them if they show any sign of deterioration or damage.

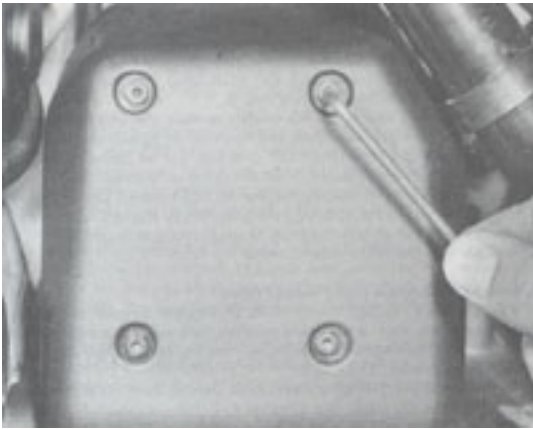

4.11 Ignition HT coil cover is retained by four Allen screws - 100 models

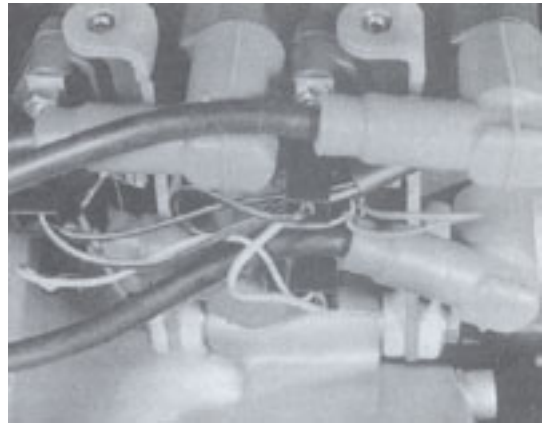

4.13a Make a written note of connections before disconnecting ignition HT coil leads

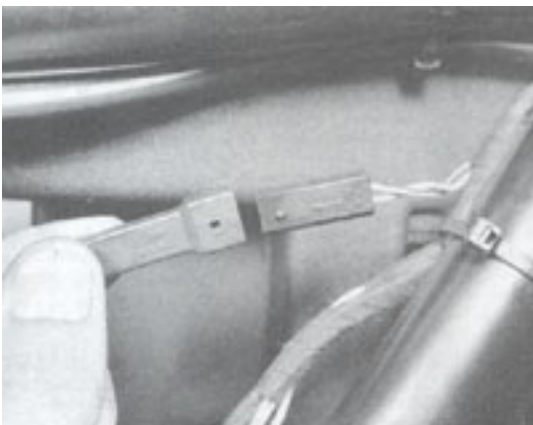

4.13b Check that all wires are disconnected between engine/transmission and frame - note speedometer transmitter wires



4.13c and ignition trigger assembly wires

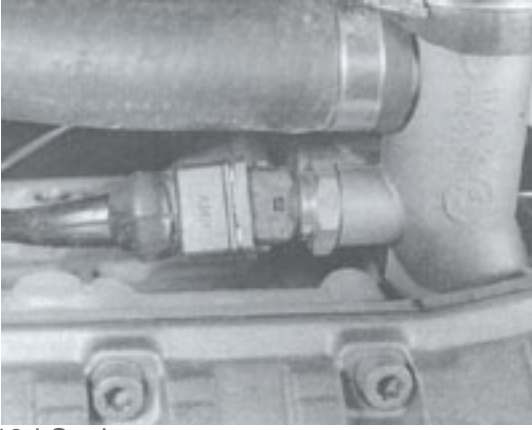

4.13d Coolant temperature sensor connector is secured by a wire clip

Chapter 1: Engine

5. Dismantling the engine unit.

<< Preliminaries and general procedures >>

Preliminary dismantling

1. If the engine/transmission unit has been removed as a single unit withdraw the alternator and starter motor ([see Chapter 10](#)) and separate the gearbox and final drive ([see Chapter 3](#)) from the bellhousing, noting that it will be necessary to remove the stand assembly to reach the two lowest gearbox/bellhousing retaining screws. There is no need to separate the final drive from the gearbox. Dismantle the clutch as described in [Chapter 2](#).
2. As described in [Chapter 5](#), remove the top half of the air filter assembly with the engine wiring harness attached to it, disconnect the loom from all other electrical components. Withdraw the air filter element and the air cleaner bottom half, the fuel rail and injectors, the plenum chamber and crankcase breather, the throttle bodies and intake stubs and the EECS pressure relief valve end hoses (where fitted).
3. Remove the coolant hose stub. [See Chapter 4](#).
4. Remove the ignition HT coils, noting carefully where the HT leads are connected, see Chapter 6. Remove the spark plugs and HT leads as described in Routine Maintenance.
5. If necessary, remove the sump (oil pan) and pump pick-up as described in Chapter 5, and remove the oil/water pump assembly as described in Chapters 4 and 5.
6. Remove the ignition trigger assembly as described in Chapter 6.

General procedures

7. If any of the following operations are to be carried out with the main cylinder block still in the frame, ensure that the machine is supported firmly on the center stand. It

is less tiring if the machine can be raised off the ground on a strong, low, bench. Have blocks to hand for supporting the rear of the machine, especially if the rear wheel is to be removed.

8. Before commencing any work involving the electrical system, disconnect the battery negative (earth) lead at the terminal to prevent any risk of short circuits.
9. On KI00 RS, KI00 RT and KI00 LT models it will usually be necessary to remove the fairing knee pads and lower sections (side panels and radiator cover) to gain adequate access to components, refer to Chapter 7 for full details. The complete fairing can be removed to eliminate any risk of damage, if required. Where fitted, remove the belly fairing or engine spoiler.
See Chapter 7.
10. Before any dismantling work is undertaken, the external surfaces of the unit should be thoroughly cleaned and degreased. This will prevent the contamination of the engine internals, and will also make working a lot easier and cleaner. A high flash-point solvent, such as paraffin (kerosene) can be used, or better still, a proprietary engine degreaser such as Gunk. Use old paintbrushes and toothbrushes to work the solvent into the various recesses of the engine castings. Take care to exclude solvent or water from the electrical components and intake and exhaust ports. The use of petrol (gasoline) as a cleaning medium should be avoided, because the vapour is explosive and can be toxic if used in a confined space.
11. When clean and dry, arrange the unit on the workbench, leaving a suitable clear area for working. Gather a selection of small containers and plastic bags so that parts can be grouped together in an easily identifiable manner. Some paper and a pen should be on hand to permit notes to be made and labels attached where necessary. A supply of clean rag is also required.
12. Before commencing work, read through the appropriate section so that some idea of the necessary procedure can be gained. When removing the various engine components great force is seldom required, unless specified. In many cases, a component's reluctance to be removed is indicative of an incorrect approach or removal method. If in any doubt, re-check with the text.
13. **Note:** All descriptions of locations ie left, right, front and rear refer to components as they would be if installed in the machine with the rider normally seated. Given the potential for confusion with this engine design the terms 'top end' and 'bottom end', referring respectively to the cylinder head and crankshaft assemblies, have been avoided if at all possible. However in some unavoidable cases, mention has been made of 'upper' or 'lower' components,- these refer to the upper side, ie the intake side or top surface of the engine or to the lower side, ie the exhaust side or underneath (sump/oil pan) of the engine. Bear this in mind at all times, but particularly if the engine is supported in some unusual position on the workbench.

Chapter 1: Engine

10. Dismantling the engine unit.

<< removing the pistons and connecting rods >>

1. If the engine is in the frame, the cylinder head must be removed first, with all preliminary dismantling work that this entails. See [Section 9](#).
2. Rotate the crankshaft by means of an Allen key applied to the ignition rotor flange retaining bolt. On 75 models one piston/connecting rod assembly will have to be dealt with at a time, with the crankshaft being rotated first to bottom dead centre (BDC) and then to top dead centre (TDC) as

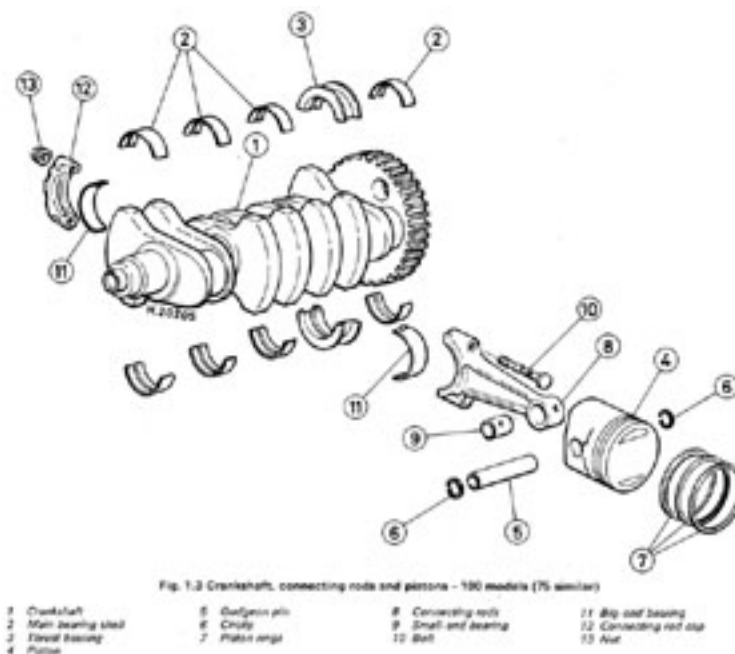

fig. 1.3 Crankshaft, connecting rods and pistons - 100 models (75 similar)

Chapter 1: Engine

9. Dismantling the engine unit.

<< removing the cylinder head >>

1. If the engine is in the frame a large amount of preliminary dismantling is necessary before the head can be removed. Proceed as follows, referring to [Section 4](#) of this Chapter for information on the full procedures
2. On KI00 RS, KI00 RT and KI00 LT models remove the fairing kneepads and lower side sections and radiator cover. On K75 S models, owners may wish to gain additional working space by removing the fairing. The engine spoiler or belly fairing and the radiator cover panels (where fitted) must be removed. Lift the seat, remove both side panels and disconnect the battery (negative terminal first) then remove the fuel tank and the exhaust system.
3. Remove the air intake hose; drain the cooling system and disconnect the radiator bottom hose. Remove the ignition HT coil cover and disconnect the throttle and choke cables.
4. Slacken the intake stub clips and the clips at the plenum chamber ends of the crankcase breather and air filter hoses. Disconnect the fuel rail hoses and the fuel injector wires, also all electrical leads from components on the throttle body assembly.
5. Noting that it may be necessary to gain extra working space by removing the air filter top and the element, carefully withdraw the plenum chamber/throttle body assembly, ensuring that all control cables and electrical leads are disconnected, also the fuel and vacuum hoses from the pressure regulator.
6. Disconnect the radiator top hose. The coolant and intake stubs and the fuel rail and injectors need only be removed, if required. Remove the HT leads and spark plugs.
7. Referring to [Sections 6](#) and [Section 8](#) of this Chapter, remove the engine outer covers and the camshafts and cam chain components.
8. Check that all components have been removed or disconnected which will prevent the lifting of the cylinder head, then remove the engine front left-hand mounting bolt

and nut, noting the presence and number of any shims which might be fitted.

9. Working in a diagonal sequence from the outside inwards, progressively and evenly slacken the cylinder head bolts and then remove them with their washers; there are 8 bolts on 75 models, ten on 100 models.
10. Tap the head firmly at a suitably-reinforced point to break the seal without risking damage and withdraw it.
11. Peel off the gasket and discard it. Note the two locating dowels; unless firmly fixed in the cylinder block these should be removed and stored safely.

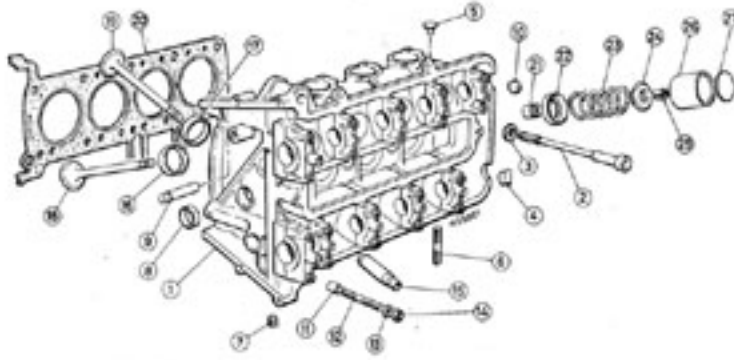

Fig. 1.2 Cylinder head and valves - 100 models (75 similar)

- | | | | |
|-------------------|----------------------------|---------------------------------|-------------------------------|
| 1 Cylinder head | 8 Core plug - 2 off | 15 Valve guide - 8 off | 22 Spring bottom seat - 8 off |
| 2 Bolt - 10 off | 9 Chain guide mounting pin | 16 Intake valve seat - 4 off | 23 Spring - 8 off |
| 3 Washer - 10 off | 10 Core plug - 2 off | 17 Exhaust valve seat - 4 off | 24 Top roller - 8 off |
| 4 Plug - 2 off | 11 Dowel - 4 off | 18 Intake valve - 4 off | 25 Split roller - 16 off |
| 5 Plug - 2 off | 12 Stud - 20 off | 19 Exhaust valve - 4 off | 26 Cam follower - 8 off |
| 6 Seal - 8 off | 13 Washer - 20 off | 20 Head gasket | 27 Shim - as required |
| 7 Threaded plug | 14 Nut - 20 off | 21 Valve guide oil seal - 8 off | |

fig. 1.2 Cylinder head and valves

MANUAL

Chapter 1: Engine

6. Dismantling the engine unit.

<< removing the outer covers >>

General

1. While specific instructions are given below for each cover, the following general notes apply to all.
2. Since all are well above the level of oil there is no need to drain the engine oil before removing any of these covers but be prepared to mop up or catch the small amount of oil that will be released as the cover is removed.
3. Wipe off all traces of dirt from around the cover before removing it, so that nothing drops into the engine.
4. Take care not to stretch or damage the rubber seals fitted to the cylinder head and crankcase covers; these can be re-used many times if they are undamaged.
5. Always slacken screws by a turn at a time, working in a diagonal sequence from the outside inwards. When all pressure is released, remove the screws, tap the cover lightly once or twice with a soft-faced mallet to break the seal and pull the cover away.

Cylinder head (engine left-hand) cover

6. On KI00 RT and KI00 LT models remove the fairing left-hand knee pad and lower side section. Where fitted, remove the belly fairing, or engine spoiler. [See Chapter 7](#). Remove the spark plug cover ([see Routine Maintenance](#)) and pack the spark plug channel with rag or similar to prevent oil from flowing into it.
7. On early KI00 and KI00 RS models remove the two drain plugs screwed into the cover and place the machine on its side stand so that any oil remaining in the cover can drip out. On all other models be prepared to catch the residual oil as the cover is removed.

8. Remove the ten (75 models) or twelve (100 models) bolts securing the cover and withdraw it, noting the presence of the coil spring fitted to one of the camshaft bearing caps. Mop up any spilt oil; **do not** allow oil flow into the spark plug channel.

Crankshaft (engine right-hand) cover

9. On KI00 RS, KI00 RT and KI00 LT models remove the fairing right-hand knee pad, lower side section and radiator cover. Where fitted, remove the engine spoiler or belly fairing and the radiator cover panels. [See Chapter 7.](#)
10. Drain the coolant if not already done, then disconnect and remove the radiator bottom hose. [See Chapter 4.](#)
11. Remove the eight (75 models) or ten (100 models) bolts securing the cover and withdraw it.

Cam chain (engine front) cover

12. It is possible to remove this cover after merely slackening the crankshaft cover bolts and removing the two cylinder head cover front bolts; however this is not recommended as it is not possible to clean the sealing surfaces well enough to guarantee a leak-free joint on reassembly. Start by removing both engine side covers as described in paragraphs 6-11 above.
13. Remove the complete ignition trigger assembly as described in [Chapter 6.](#)
14. Disconnect the oil pressure switch wire and feed it downwards clear of the front cover, releasing the metal securing clips. Remove the horn (75 models only).
15. Remove the cover retaining screws and withdraw the cover noting the two gaskets, one along each mating surface, and the two locating dowels set in the top mating surface. Always renew the gaskets to prevent leaks.

Chapter 1: Engine

7. Dismantling the engine unit.

<< removing the bellhousing and auxiliary drive shaft components >>

1. If the engine unit is in the frame, remove first the gearbox and final drive ([Chapter 3](#)), the alternator ([Chapter 10](#)) and the ignition HT coils ([Chapter 6](#)). Remove the clutch ([see Chapter 2](#)), but while the housing is locked to permit the retaining nut to be unscrewed, slacken also the bolt securing the alternator drive flange to the auxiliary shaft. Remove the crankshaft cover. [See Section 6](#).
2. Owners will now have to devise some means of supporting securely the frame rear end and the engine at the same time. Note that when the frame/bellhousing mounting bolt is removed the engine will pivot, however slightly, on its two front mountings thus causing a risk of damage to other components and problems with alignment on reassembly. Only secure supports can prevent this.
3. If the frame rear end is hanging from an overhead support, as described in [Chapter 8](#), great care must be taken not to jar the frame while the bellhousing is removed. Note that jacks should not be used to support heavy components for any length of time; they are for lifting only. Use car axle stands, blocks of wood or similar to hold the engine and frame securely at the required height.
4. When the machine is securely supported remove the bellhousing mounting bolt and any shims that may be fitted.
5. If the engine is removed from the frame temporarily refit the clutch housing and lock it as described in [Chapter 2](#) to permit the alternator drive flange retaining bolt to be slackened. Remove the bolt and withdraw the drive flange, noting that the O-ring and thrust washer behind it may be dislodged.
6. While in practice the flange was found to be a fairly slack fit and was easily pulled away by hand, it may require a sharp tap from a hammer and a soft metal drift or a wooden dowel (to avoid damaging the shaft) on the auxiliary shaft rear end to jar it free. BMW state that a two-legged puller, with an adaptor to protect the shaft end, is required to remove the flange; it will probably be necessary to grind down the

puller claws so that they will fit between the flange and the bellhousing.

7. Remove the bellhousing/crankcase retaining screws. These are Torx screws, size T30, and will require the use of a suitable key to remove and refit them. Torx keys are available at most specialist tool shops and some auto accessory shops; it is useful to purchase a key that is attached to a socket so that a torque wrench can be used to fasten them.
8. When all the screws are removed, tap the bellhousing sharply with a soft-faced mallet to break the seal and withdraw it, noting the presence of the two locating dowels. Check carefully that the starter idler shaft and the auxiliary drive shaft are not dislodged with the bellhousing.
9. Carefully pull the starter idler shaft out of the crankcase and note exactly how the spring behind it (if fitted on early 100 models) is fitted before removing it. Withdraw the auxiliary drive shaft as a single unit.

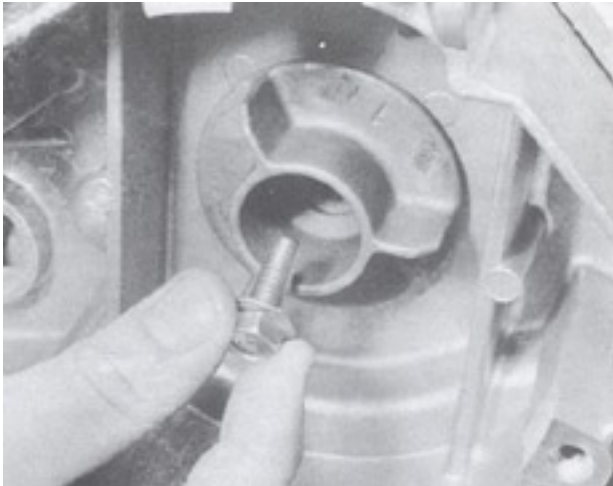

7.5 Lock crankshaft to permit removal of alternator drive flange retaining bolt

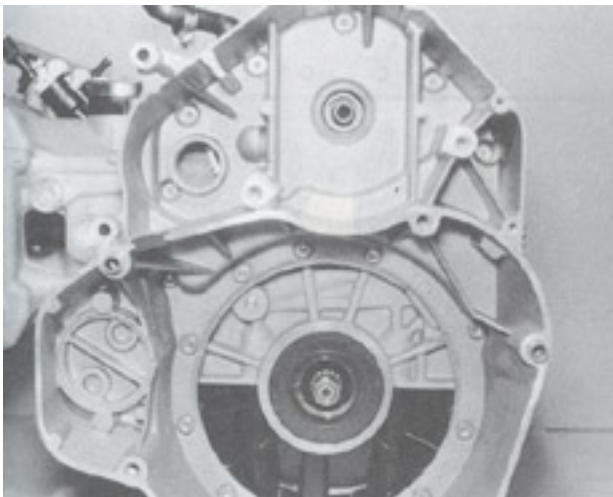

7.7a Bellhousing / crankcase retaining screws are of

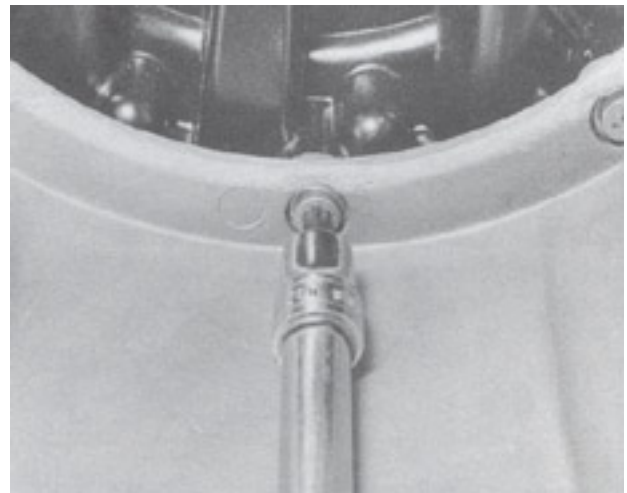

7.7b Torx type - special key required for removal and refitting

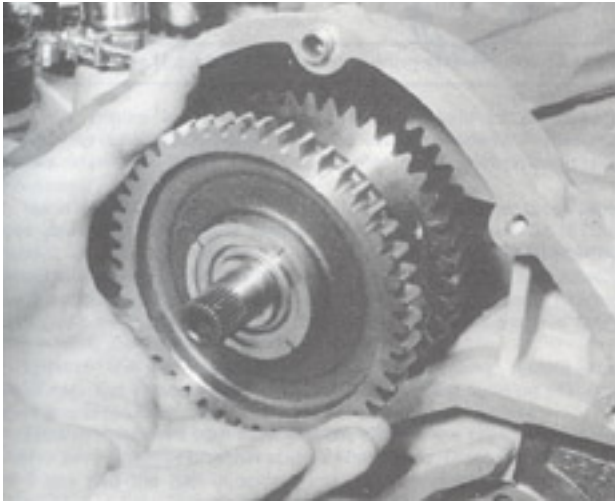

7.9 Remove auxiliary drive shaft as a single unit

Chapter 1: Engine

8. Dismantling the engine unit.

<< removing the camshafts and cam chain >>

1. If the engine unit is in the frame, remove first the engine outer covers, as described in [Section 6](#) of this Chapter. Remove the sparkplugs, as described in [Routine Maintenance](#).
2. Rotate the crankshaft by means of an Allen key placed in the ignition rotor retaining bolt until the camshafts are placed so that all valves are closed as far as possible, ie so that there is the minimum pressure possible exerted on the camshafts by the valve springs. On 75 models this position is close to Number 3 cylinder being at TDC on the compression stroke.
3. Remove the chain tensioner. Some early 100 models are fitted with a chain tensioner which can be locked by turning a screw as far as possible clockwise; the tensioner mounting screws are then removed and the unit can be withdrawn. The screw is to be found in that face of the tensioner opposite to the plunger/tensioner blade assembly. On 75 models and later 1 00 models compress the tensioner by hand, remove the mounting screws and withdraw the unit; slowly allow it to extend until the spring pressure is released.
4. Remove their retaining clips or circlips, noting the washer behind each, and withdraw the cam chain tensioner blade and chain guide. Remove its retaining screws and withdraw the chain top guide rail from between the camshafts; these are Torx screws which BMW state are size T30 but were found on the machine featured in the accompanying photographs to be size T27. Owners should ensure that both sizes of key are available.
5. In some cases there may be sufficient slack in the chain, and sufficient clearance around the sprockets, to permit its removal at this stage but usually it will be necessary to withdraw the camshaft sprockets; use an open-ended spanner to hold the camshaft at the hexagon provided, remove the bolt and withdraw the large washer and the sprocket. While these components are the same for both intake

and exhaust camshafts, it is good practice to mark them and to store them separately so that they can be refitted in their original locations. Withdraw the chain from the crankshaft sprocket.

6. If required, the ignition rotor flange end crankshaft sprocket can be withdrawn at this stage.
7. If the camshafts are to be removed, this can be done before or after the chain has been disconnected but in the former case some care will be required to avoid damaging or marking any components.
8. **Note:** Before removing the camshafts make a careful note (using a small sketch if required), of the exact location and fitted position of the bearing caps; these are clamped to the head and line-bored in a single process on manufacture and must not be refitted on any other bearing, nor reversed. The manufacturer has provided identification aids in the form of a number stamped into each bearing cap to match a number cast into the cylinder head next to the bearing pedestal; these numbers are stamped in the top of each cap above the threaded boss on the intake and below it on the exhaust and can only be read from the rear of the cylinder head looking forwards to help eliminate any possibility of their being reversed. Note that odd numbers are used for the intake and even numbers for the exhaust, except for the rear bearing on 100 models which is marked 'O' indicating '10'. If necessary, make your own identifying marks, provided this does not involve scratching a cap or using a punch. It is useful to have ready some means of retaining the cam followers and shims. [See paragraph 12.](#)
9. To avoid tilting the camshafts, remove first the front or cam chain end (thrust) bearing caps. Unscrew the nuts alternately by a turn at a time so that each bearing is released evenly and remains square. Note the locating dowels fitted at each stud of these front bearing caps. Store the caps in separate, clearly marked containers.
10. With the front bearings removed, gradually and evenly slacken the nuts on the remaining bearing caps, working from the outside inwards until all valve spring pressure is released. Withdraw the caps and store them in separate clearly-marked containers. **Note:** take a great deal of time and trouble over this - if any bearing cap is cracked or damaged by careless workmanship it can only be replaced as part of a new cylinder head assembly.
11. Withdraw the camshafts. There is no need to mark them as the bearings are offset and the cams can be refitted only in the correct location.
12. If the camshafts are to be removed, it is worthwhile to cut two lengths of wooden dowel, of a diameter similar to that of the camshaft rear bearings, and to fasten these lightly in place using the bearing caps. This will avoid the loss of any components and the risk of the cam followers and shims falling out and getting mixed up.

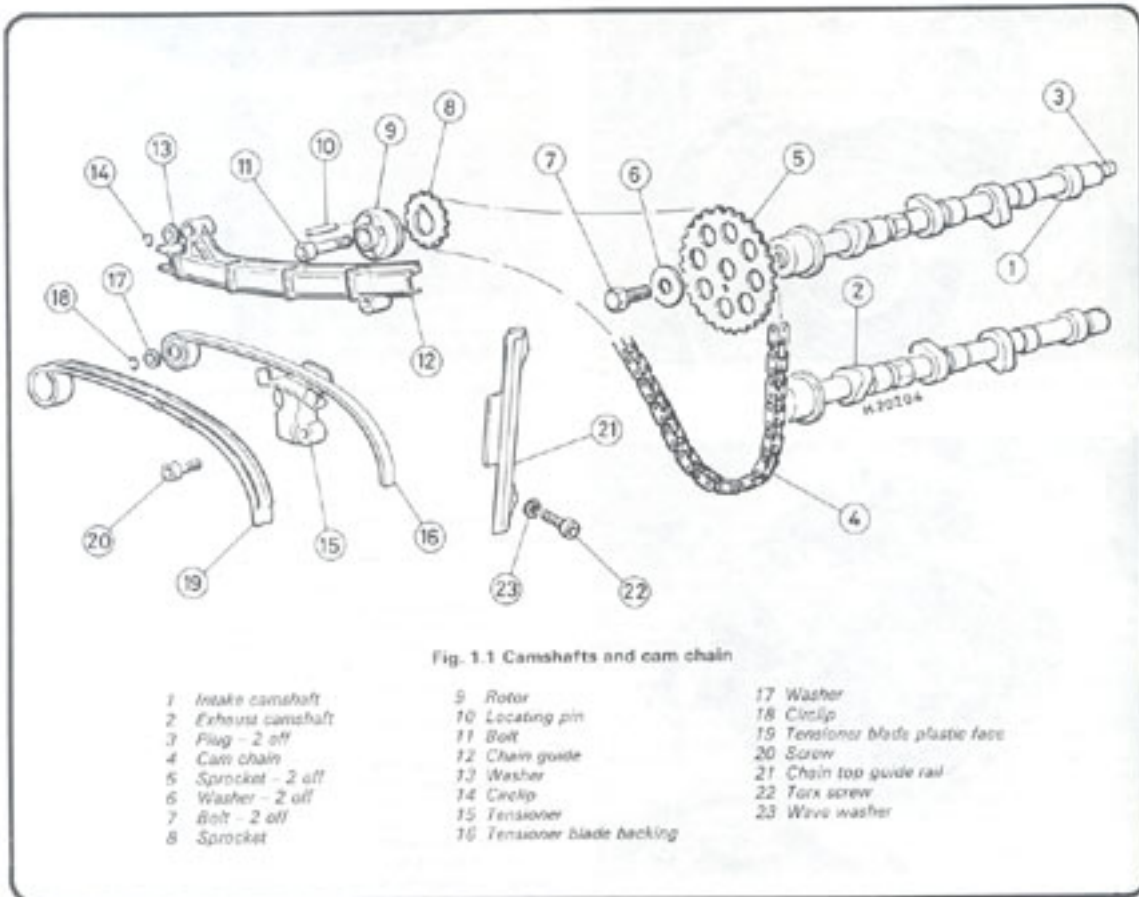
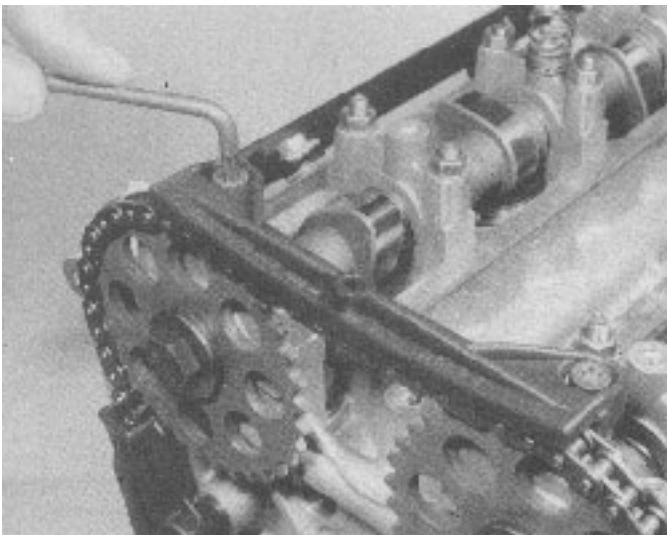
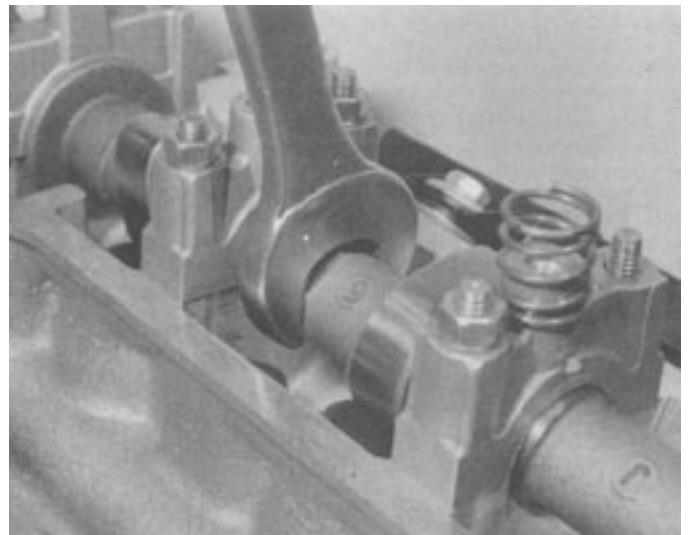

fig. 1.1 Camshaft and cam chain
[click here to enlarge drawing](#)



8.4 Cam chain top guide rail is retained by Torx screws - ensure correct size key is available



8.5 If sprockets are to be removed, hold camshaft as show while retaining bolts are unscrewed

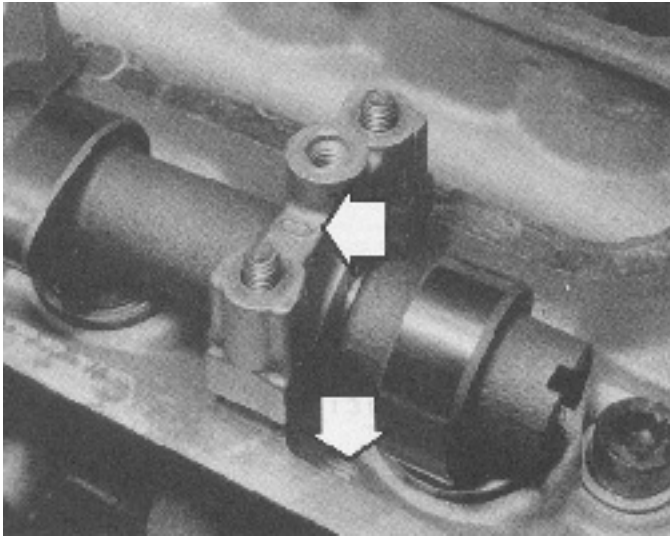

8.8 Identify camshaft bearing caps using marks provided (arrowed) before disturbing - make notes if required

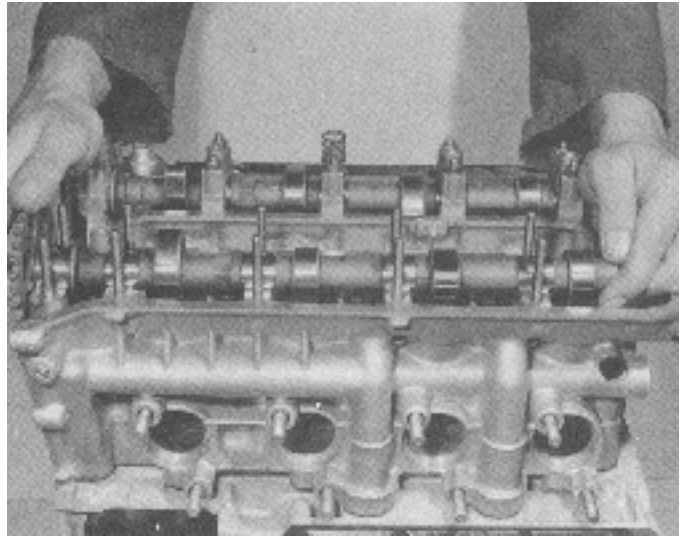

8.11 Withdraw camshafts separately to avoid mixing components - Camshaft bearings are offset, so cams themselves cannot be interchanged

Chapter 1: Engine

12. Dismantling the engine unit.

<< removing the crankshaft >>

Chapter 1: Engine

11. Dismantling the engine unit.

<< removing the crankcase lower section and the output/balancer shaft >>

8. Dismantling the engine unit.

<< drawing Camshaft and cam chain >>

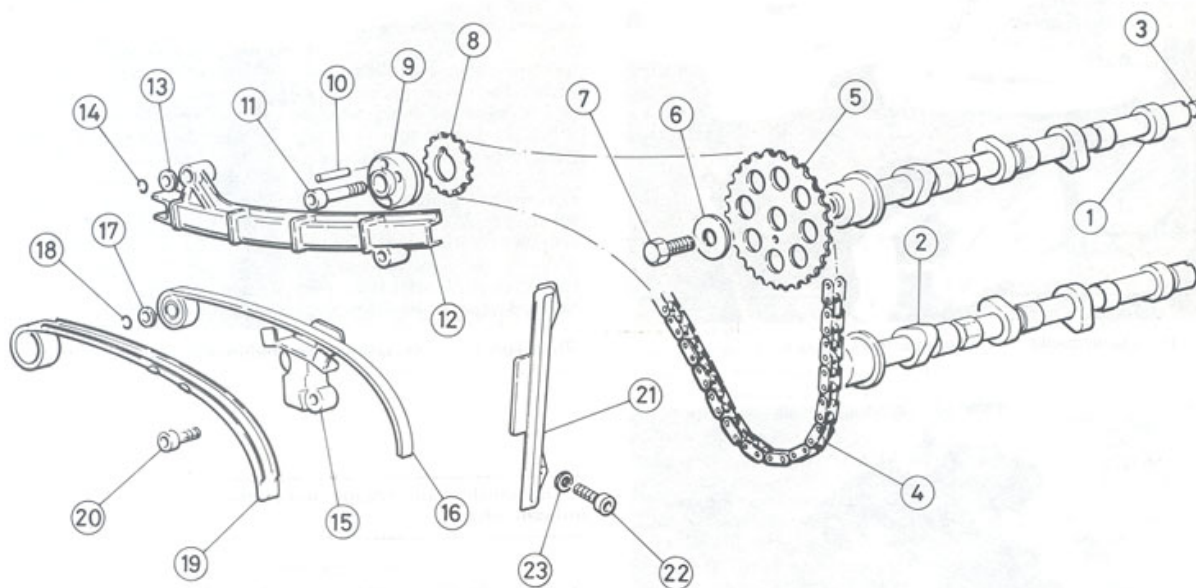

Fig. 1.1 Camshafts and cam chain

- | | | |
|--------------------|----------------------------|---------------------------------|
| 1 Intake camshaft | 9 Rotor | 17 Washer |
| 2 Exhaust camshaft | 10 Locating pin | 18 Circlip |
| 3 Plug - 2 off | 11 Bolt | 19 Tensioner blade plastic face |
| 4 Cam chain | 12 Chain guide | 20 Screw |
| 5 Sprocket - 2 off | 13 Washer | 21 Chain top guide rail |
| 6 Washer - 2 off | 14 Circlip | 22 Torx screw |
| 7 Bolt - 2 off | 15 Tensioner | 23 Wave washer |
| 8 Sprocket | 16 Tensioner blade backing | |

9. Dismantling the engine unit.

<< drawing Cylinder head and valves - 100 models (75 similar) >>

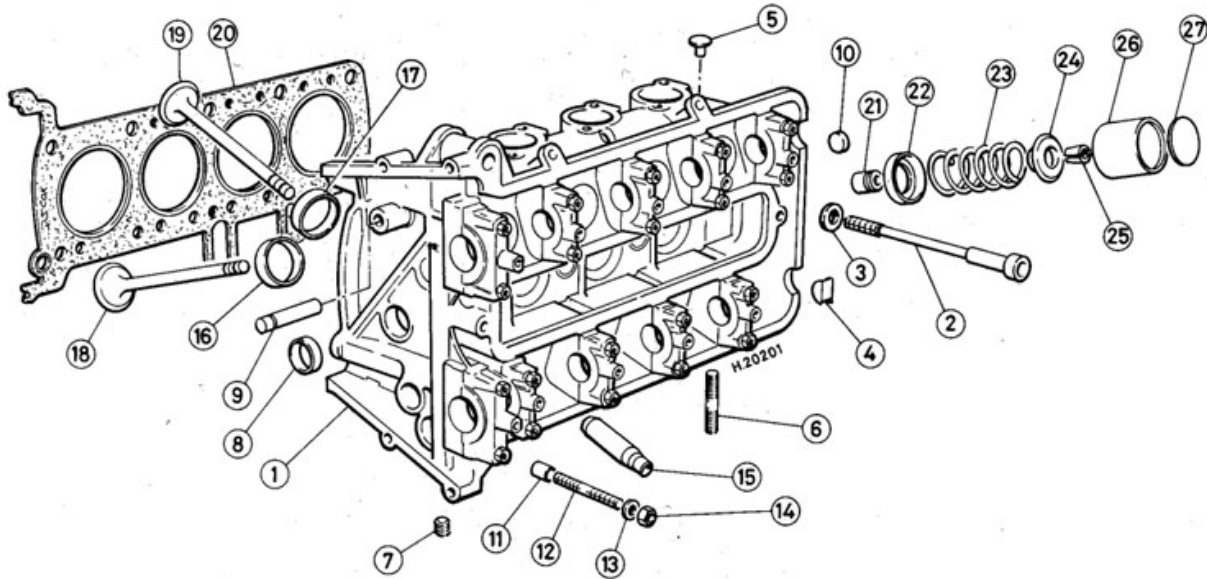

Fig. 1.2 Cylinder head and valves - 100 models (75 similar)

- | | | | |
|-------------------|----------------------------|---------------------------------|-------------------------------|
| 1 Cylinder head | 8 Core plug - 2 off | 15 Valve guide - 8 off | 22 Spring bottom seat - 8 off |
| 2 Bolt - 10 off | 9 Chain guide mounting pin | 16 Intake valve seat - 4 off | 23 Spring - 8 off |
| 3 Washer - 10 off | 10 Core plug - 2 off | 17 Exhaust valve seat - 4 off | 24 Top collar - 8 off |
| 4 Plug - 2 off | 11 Dowel - 4 off | 18 Intake valve - 4 off | 25 Split collet - 16 off |
| 5 Plug - 2 off | 12 Stud - 20 off | 19 Exhaust valve - 4 off | 26 Cam follower - 8 off |
| 6 Stud - 8 off | 13 Washer - 20 off | 20 Head gasket | 27 Shim - as required |
| 7 Threaded plug | 14 Nut - 20 off | 21 Valve guide oil seal - 8 off | |

10. Dismantling the engine unit.

<< drawing Crankshaft, connecting rods and pistons - 100 models (75 similar) >>

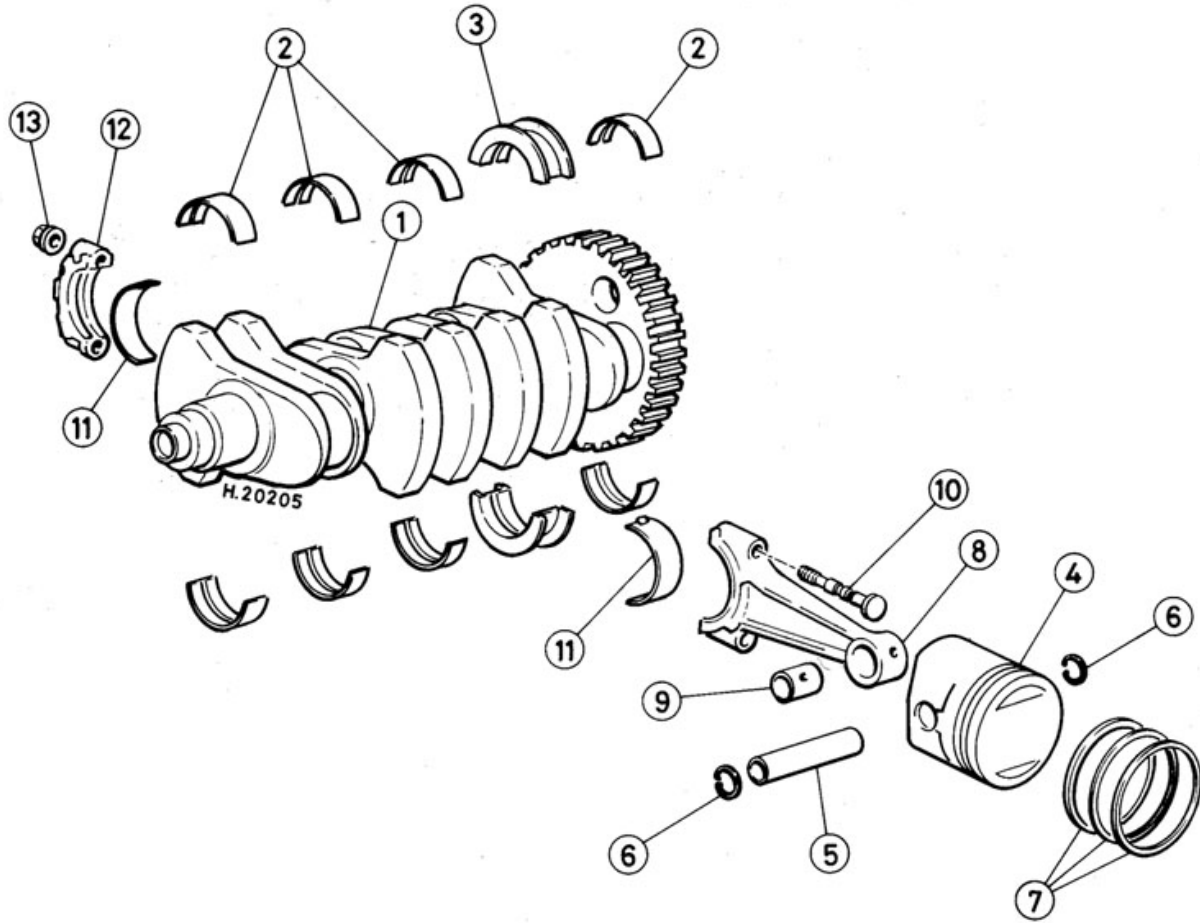
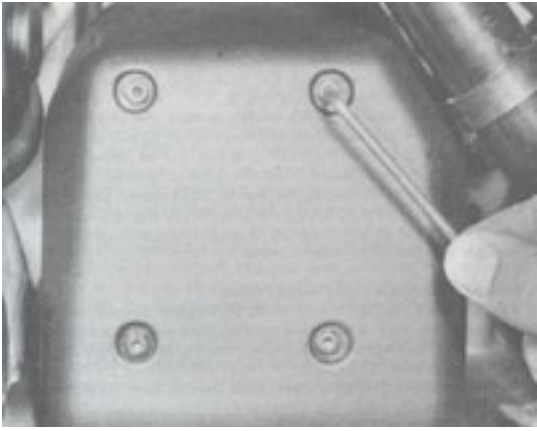
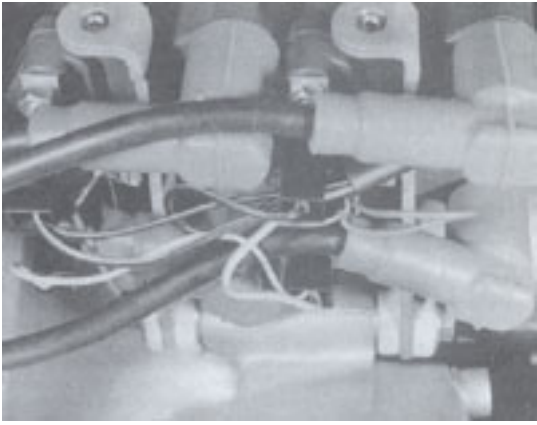
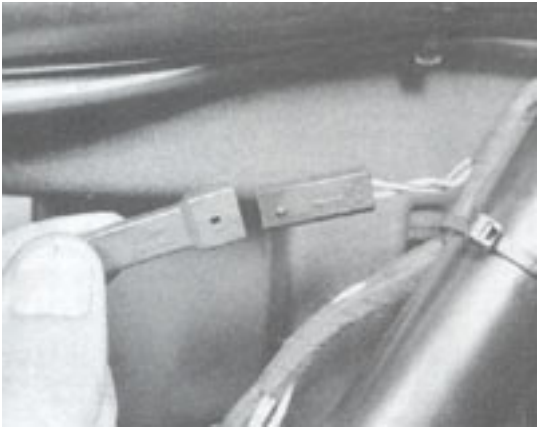

Fig. 1.3 Crankshaft, connecting rods and pistons – 100 models (75 similar)

- | | | | |
|----------------------|----------------|---------------------|-----------------------|
| 1 Crankshaft | 5 Gudgeon pin | 8 Connecting rods | 11 Big-end bearing |
| 2 Main bearing shell | 6 Circlip | 9 Small-end bearing | 12 Connecting rod cap |
| 3 Thrust bearing | 7 Piston rings | 10 Bolt | 13 Nut |
| 4 Piston | | | |









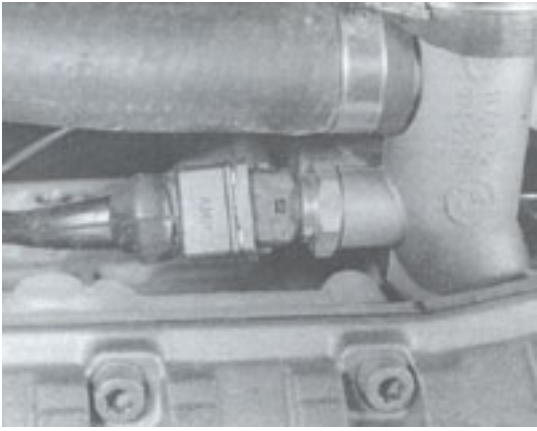

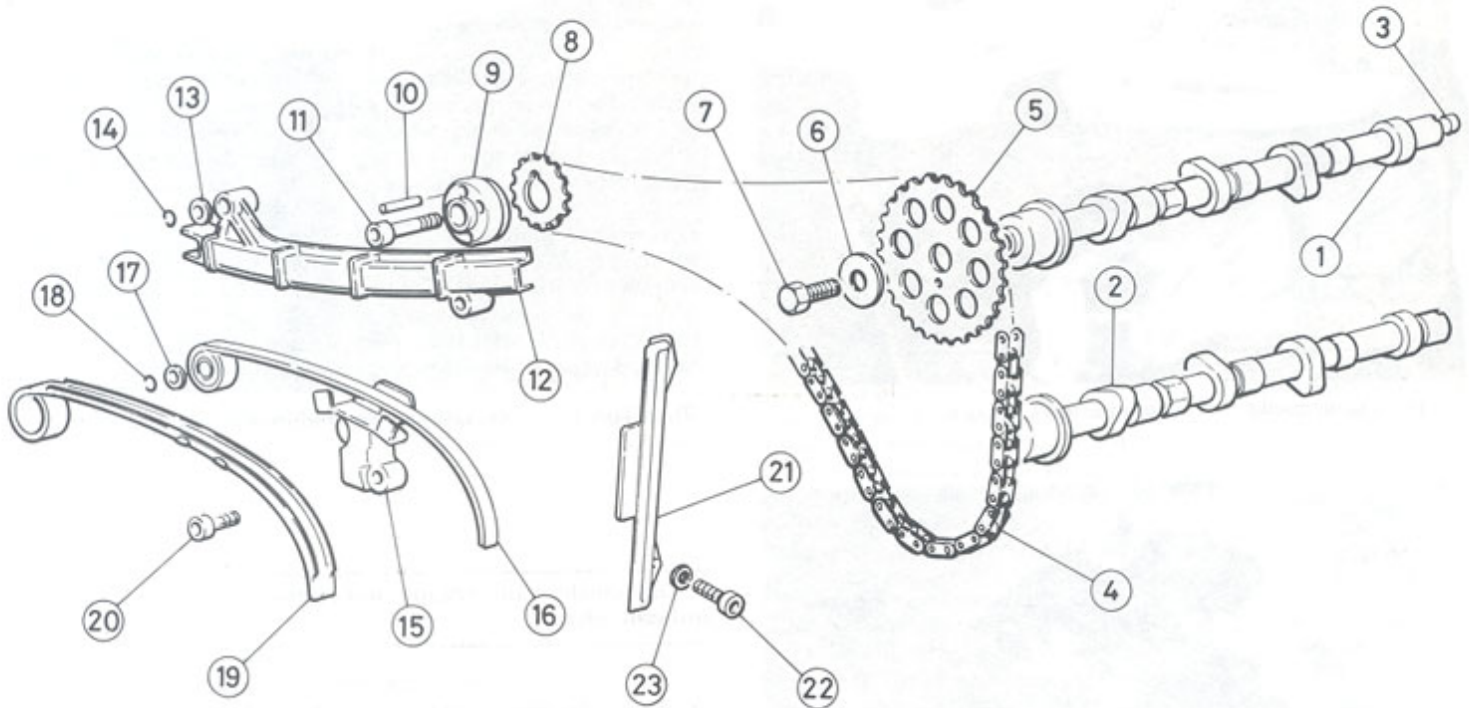

Fig. 1.1 Camshafts and cam chain

- | | | |
|--------------------|----------------------------|---------------------------------|
| 1 Intake camshaft | 9 Rotor | 17 Washer |
| 2 Exhaust camshaft | 10 Locating pin | 18 Circlip |
| 3 Plug - 2 off | 11 Bolt | 19 Tensioner blade plastic face |
| 4 Cam chain | 12 Chain guide | 20 Screw |
| 5 Sprocket - 2 off | 13 Washer | 21 Chain top guide rail |
| 6 Washer - 2 off | 14 Circlip | 22 Torx screw |
| 7 Bolt - 2 off | 15 Tensioner | 23 Wave washer |
| 8 Sprocket | 16 Tensioner blade backing | |

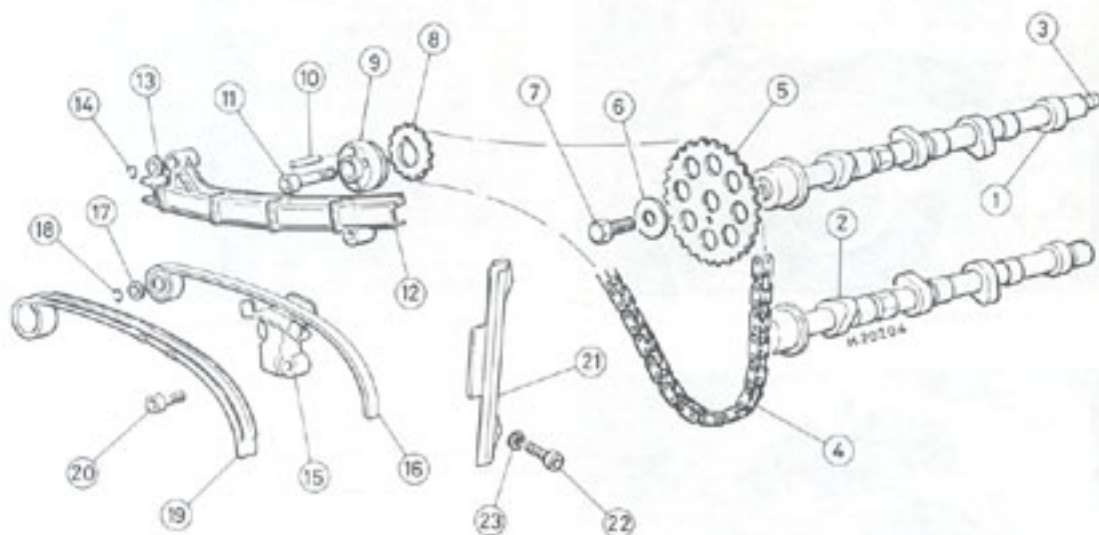

Fig. 1.1 Camshafts and cam chain

- | | | |
|--------------------|----------------------------|---------------------------------|
| 1 Intake camshaft | 9 Rotor | 17 Washer |
| 2 Exhaust camshaft | 10 Locating pin | 18 Circlip |
| 3 Plug - 2 off | 11 Bolt | 19 Tensioner blade plastic face |
| 4 Cam chain | 12 Chain guide | 20 Screw |
| 5 Sprocket - 2 off | 13 Washer | 21 Chain top guide rail |
| 6 Washer - 2 off | 14 Circlip | 22 Torx screw |
| 7 Bolt - 2 off | 15 Tensioner | 23 Wave washer |
| 8 Sprocket | 16 Tensioner blade backing | |

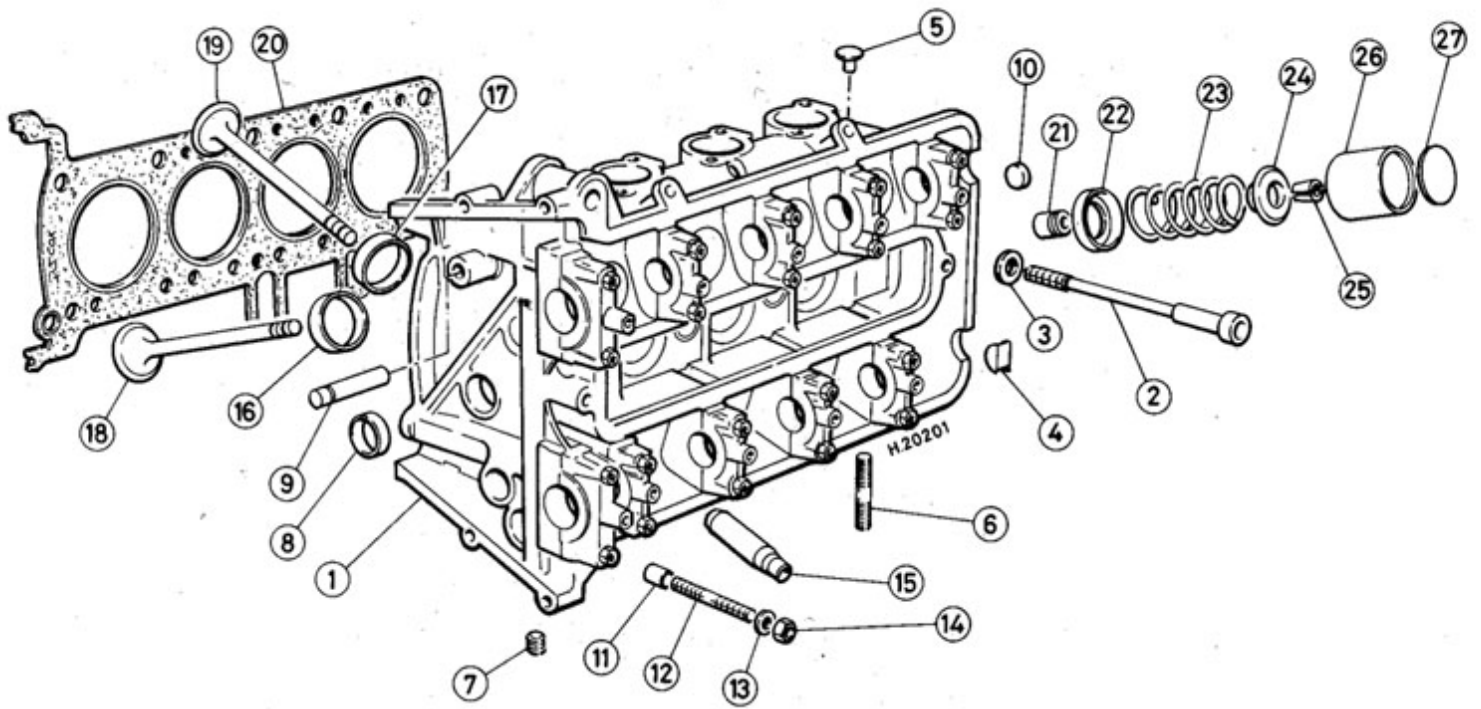

Fig. 1.2 Cylinder head and valves - 100 models (75 similar)

- | | | | |
|-------------------|----------------------------|---------------------------------|-------------------------------|
| 1 Cylinder head | 8 Core plug - 2 off | 15 Valve guide - 8 off | 22 Spring bottom seat - 8 off |
| 2 Bolt - 10 off | 9 Chain guide mounting pin | 16 Intake valve seat - 4 off | 23 Spring - 8 off |
| 3 Washer - 10 off | 10 Core plug - 2 off | 17 Exhaust valve seat - 4 off | 24 Top collar - 8 off |
| 4 Plug - 2 off | 11 Dowel - 4 off | 18 Intake valve - 4 off | 25 Split collet - 16 off |
| 5 Plug - 2 off | 12 Stud - 20 off | 19 Exhaust valve - 4 off | 26 Cam follower - 8 off |
| 6 Stud - 8 off | 13 Washer - 20 off | 20 Head gasket | 27 Shim - as required |
| 7 Threaded plug | 14 Nut - 20 off | 21 Valve guide oil seal - 8 off | |

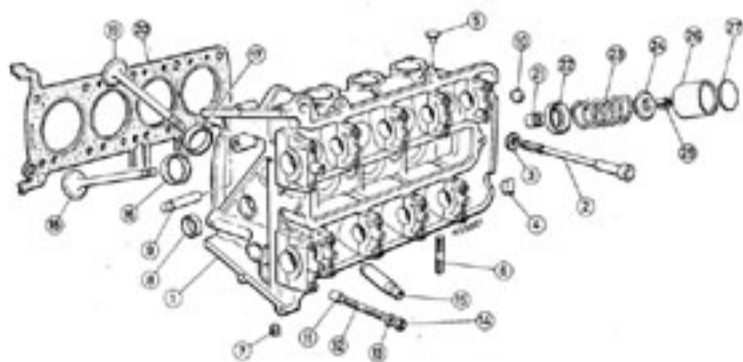

Fig. 1.2 Cylinder head and valves - 100 models (76 similar)

1 Cylinder head	8 Core plug - 2 off	15 Valve guide - 8 off	22 Spring bottom seat - 8 off
2 Bolt - 10 off	9 Chain guide mounting pin	16 Intake valve seat - 4 off	23 Spring - 8 off
3 Washer - 10 off	10 Core plug - 2 off	17 Exhaust valve seat - 4 off	24 Top roller - 8 off
4 Nut - 2 off	11 Dowel - 4 off	18 Intake valve - 4 off	25 Soft roller - 16 off
5 Plug - 2 off	12 Stud - 20 off	19 Exhaust valve - 4 off	26 Cam follower - 8 off
6 Seal - 8 off	13 Washer - 20 off	20 Head gasket	27 Shim - as required
7 Threaded plug	14 Nut - 20 off	21 Valve guide oil seal - 8 off	

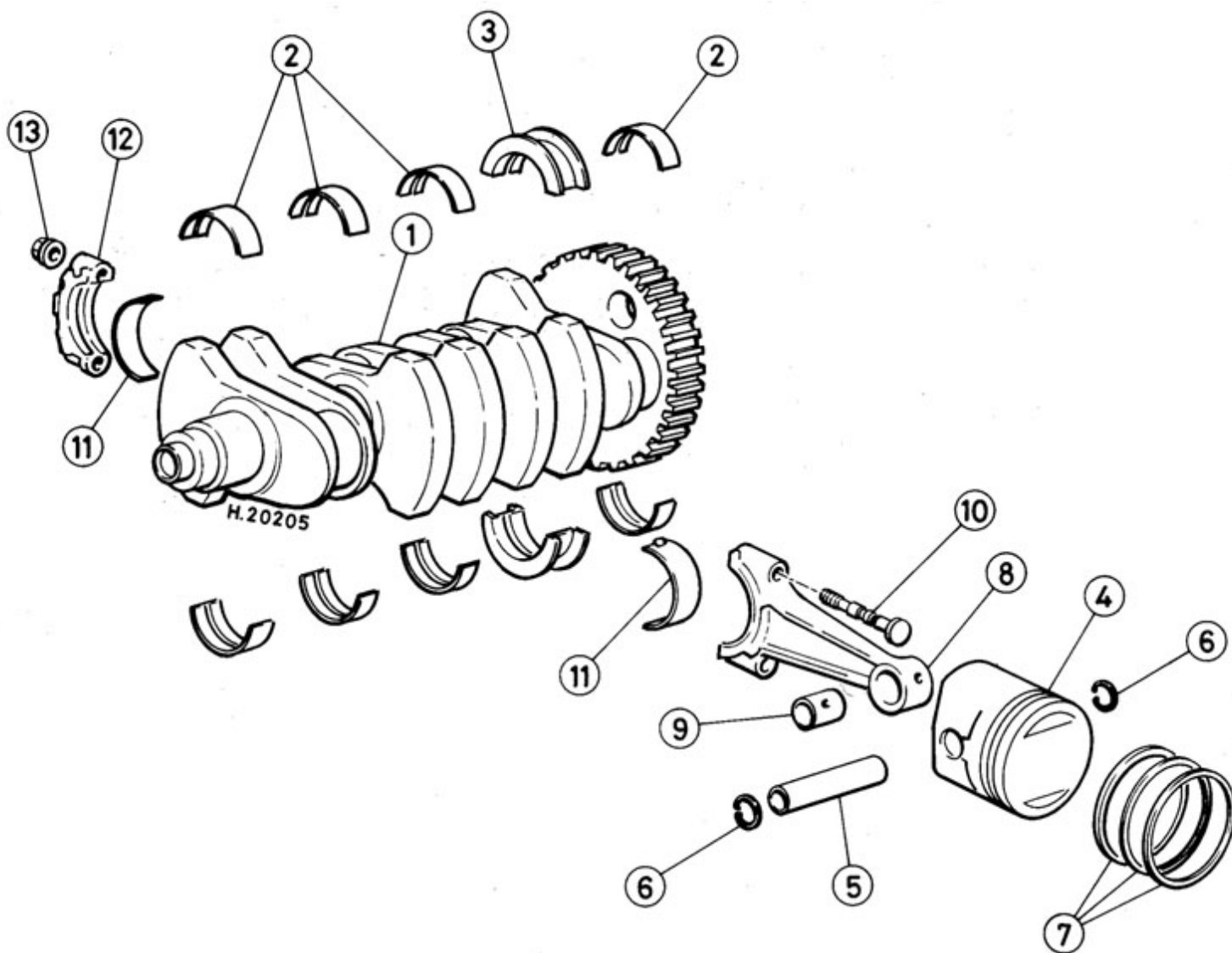

Fig. 1.3 Crankshaft, connecting rods and pistons – 100 models (75 similar)

- | | | | |
|----------------------|----------------|---------------------|-----------------------|
| 1 Crankshaft | 5 Gudgeon pin | 8 Connecting rods | 11 Big-end bearing |
| 2 Main bearing shell | 6 Circlip | 9 Small-end bearing | 12 Connecting rod cap |
| 3 Thrust bearing | 7 Piston rings | 10 Bolt | 13 Nut |
| 4 Piston | | | |

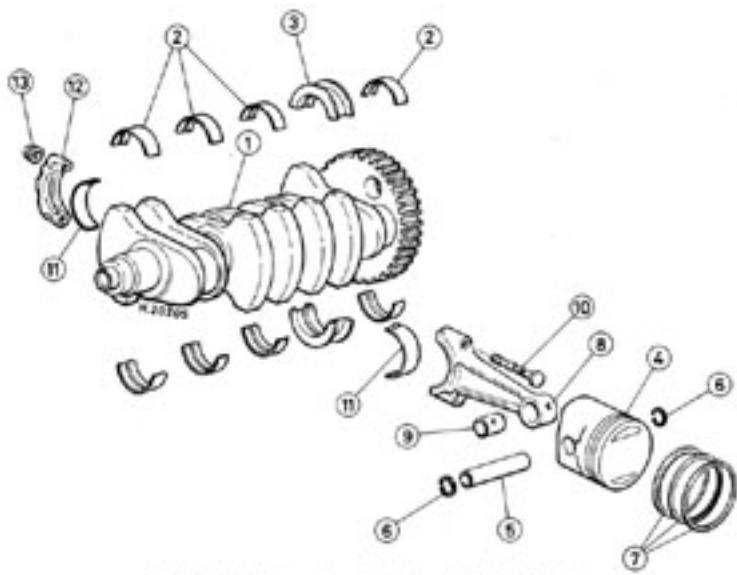
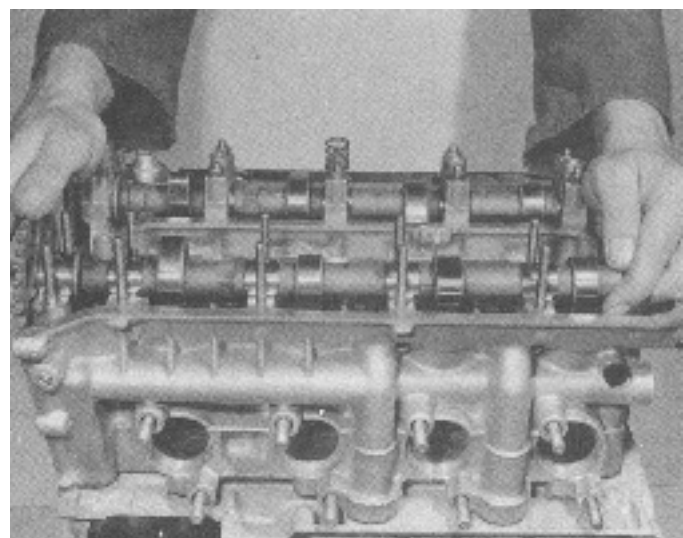
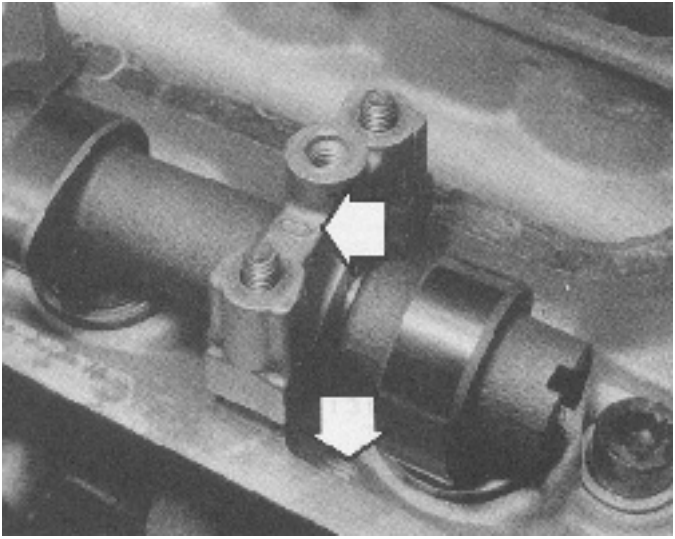

Fig. 1.3 Crankshaft, connecting rods and pistons - 100 models (75 similar)

- | | | | |
|----------------------|---------------|---------------------|-----------------------|
| 1 Crankshaft | 5 Bushpin pin | 8 Connecting rods | 11 Big end bearing |
| 2 Main bearing shell | 6 Cap | 9 Small end bearing | 12 Connecting rod cap |
| 3 Side bearing | 7 Piston pin | 10 Bolt | 13 Nut |
| 4 Piston | | | |







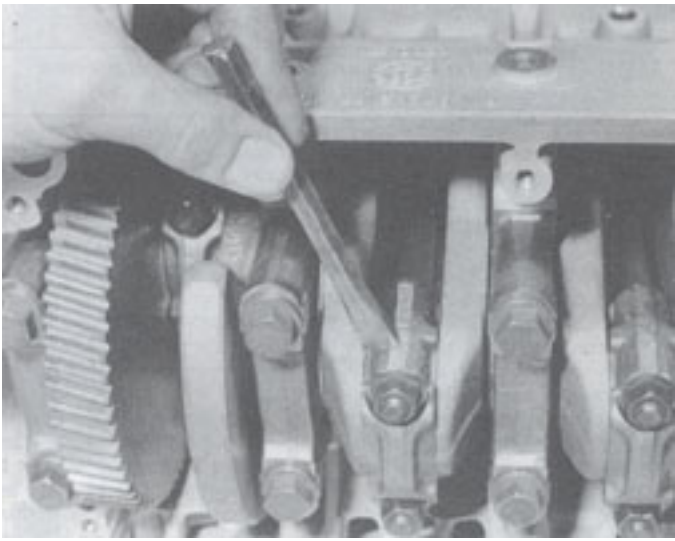

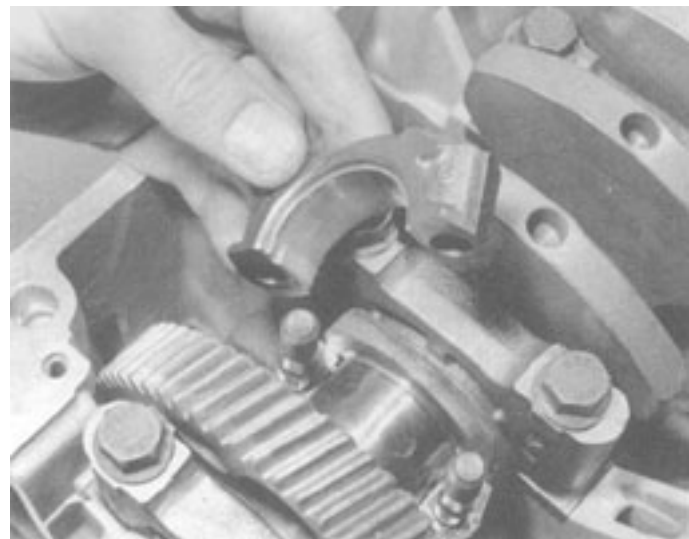

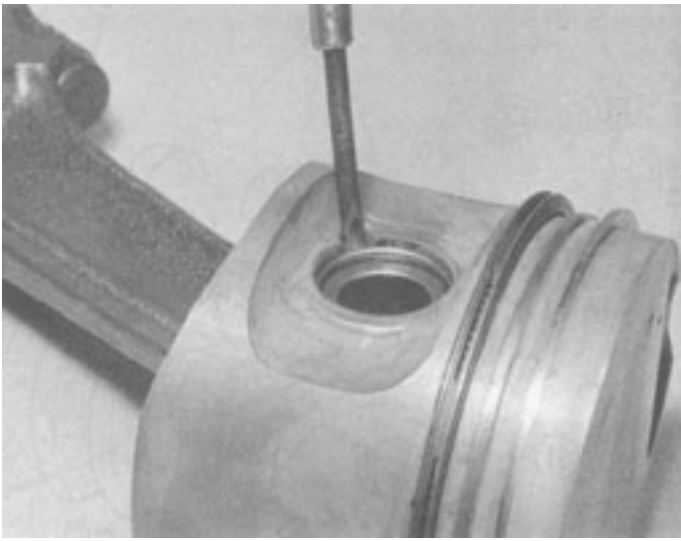

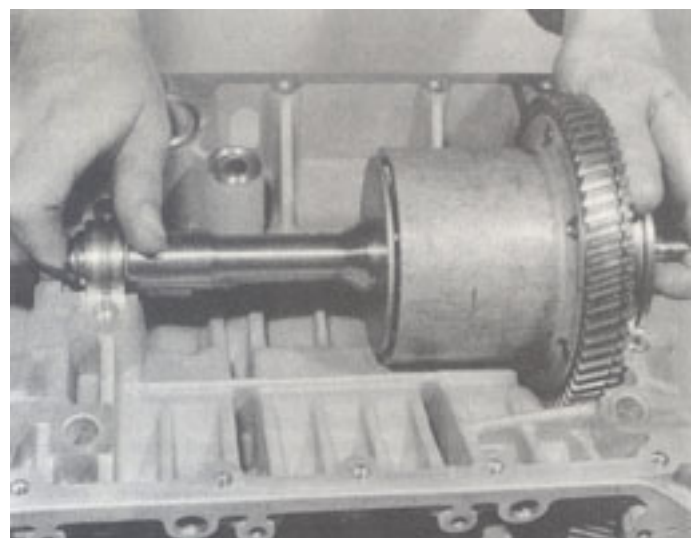

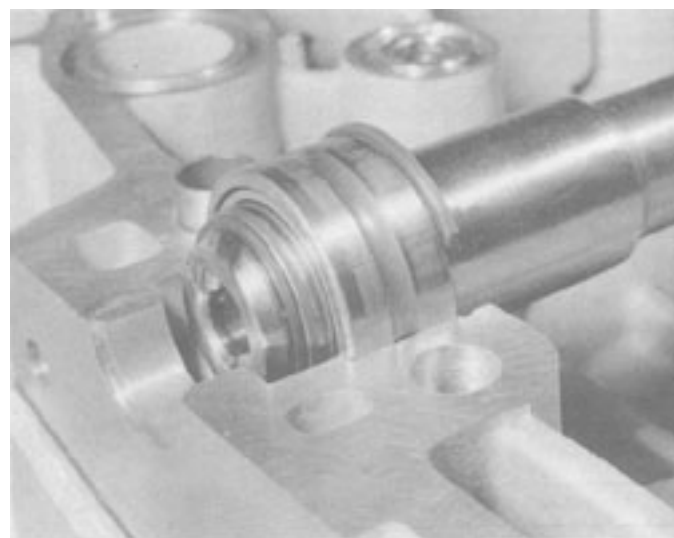

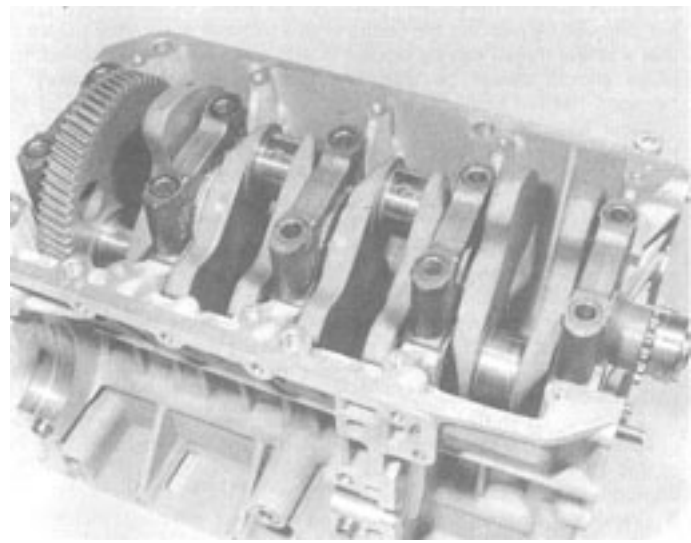

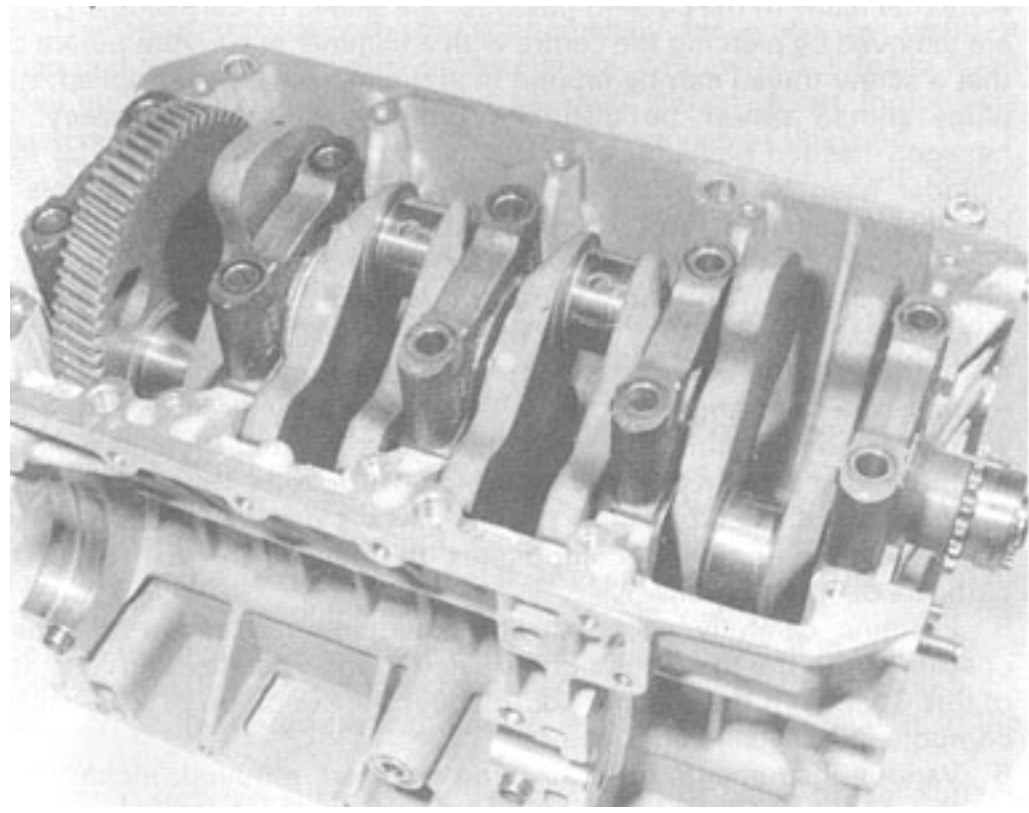

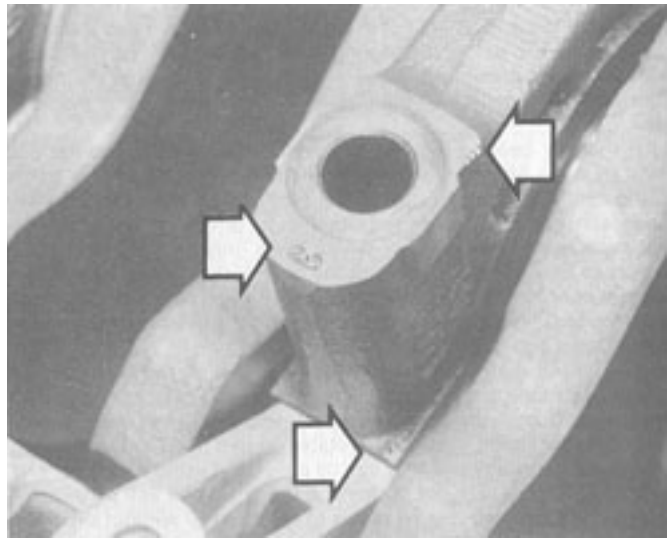

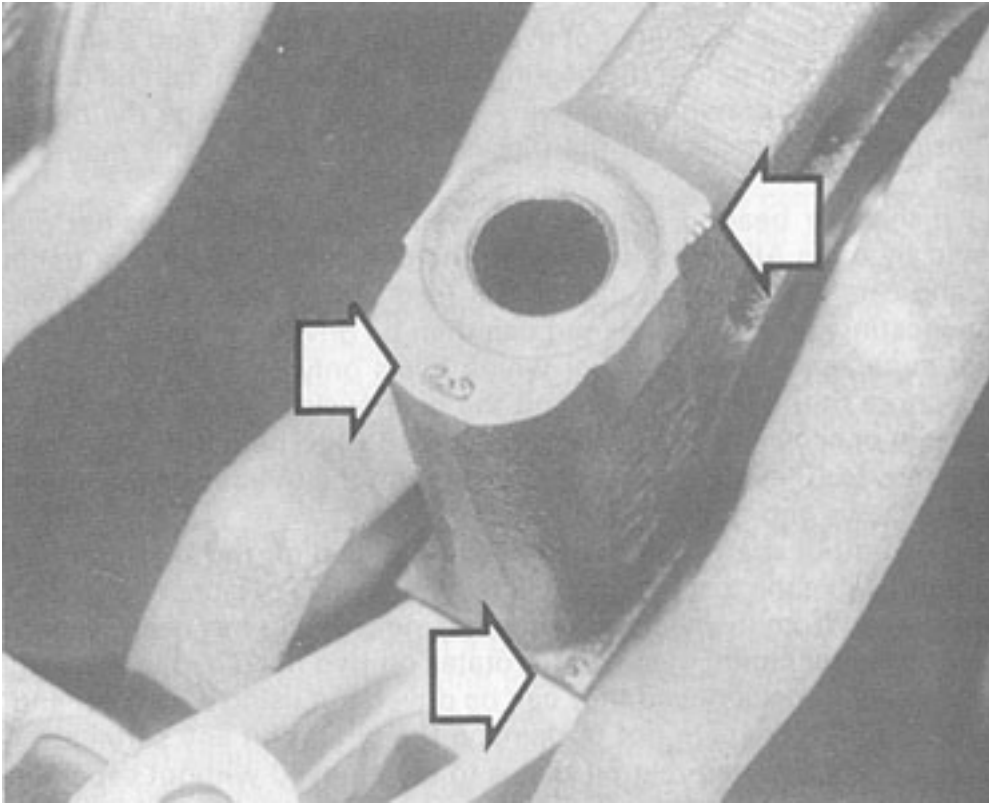

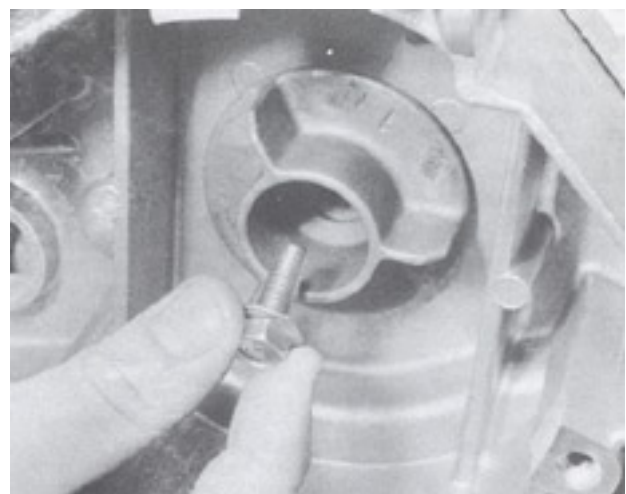

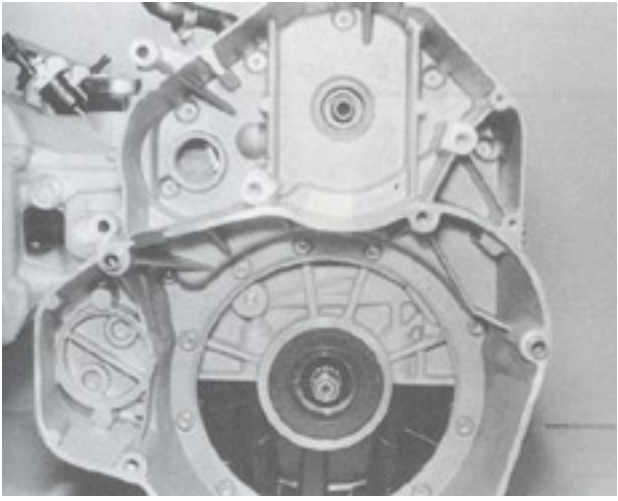

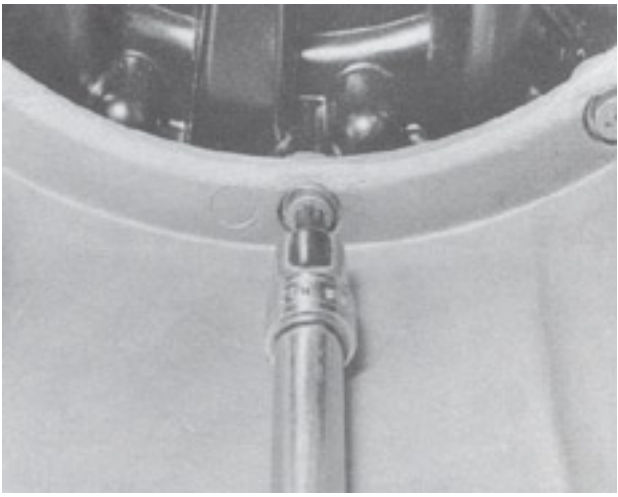

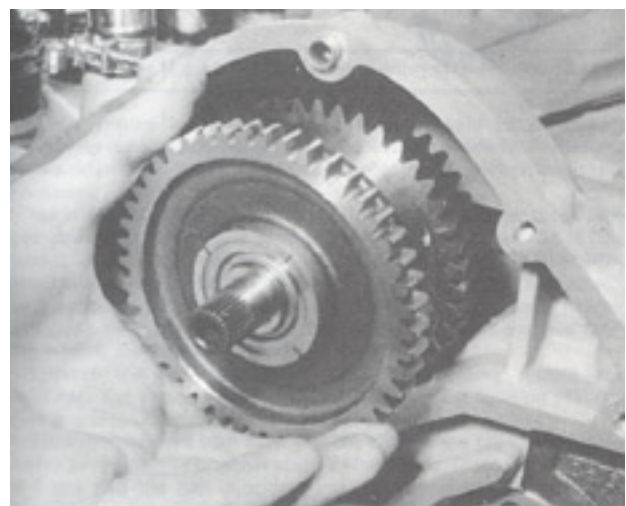

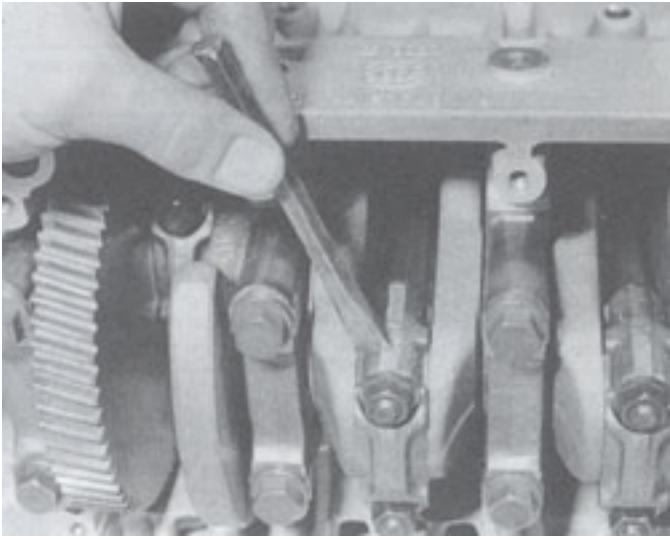

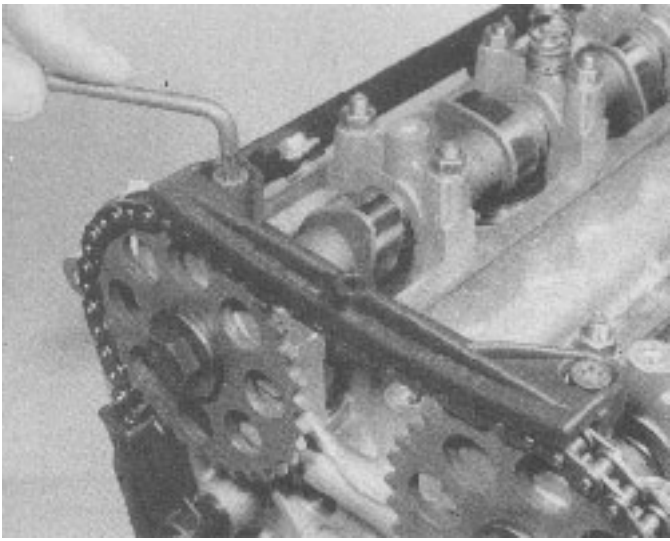

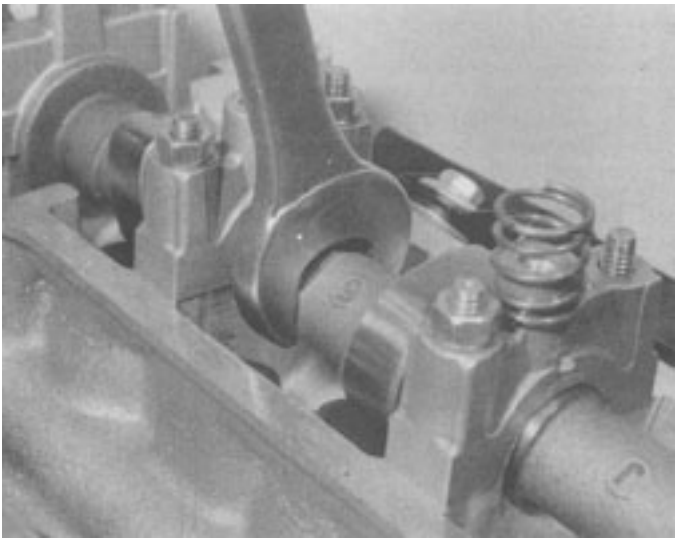

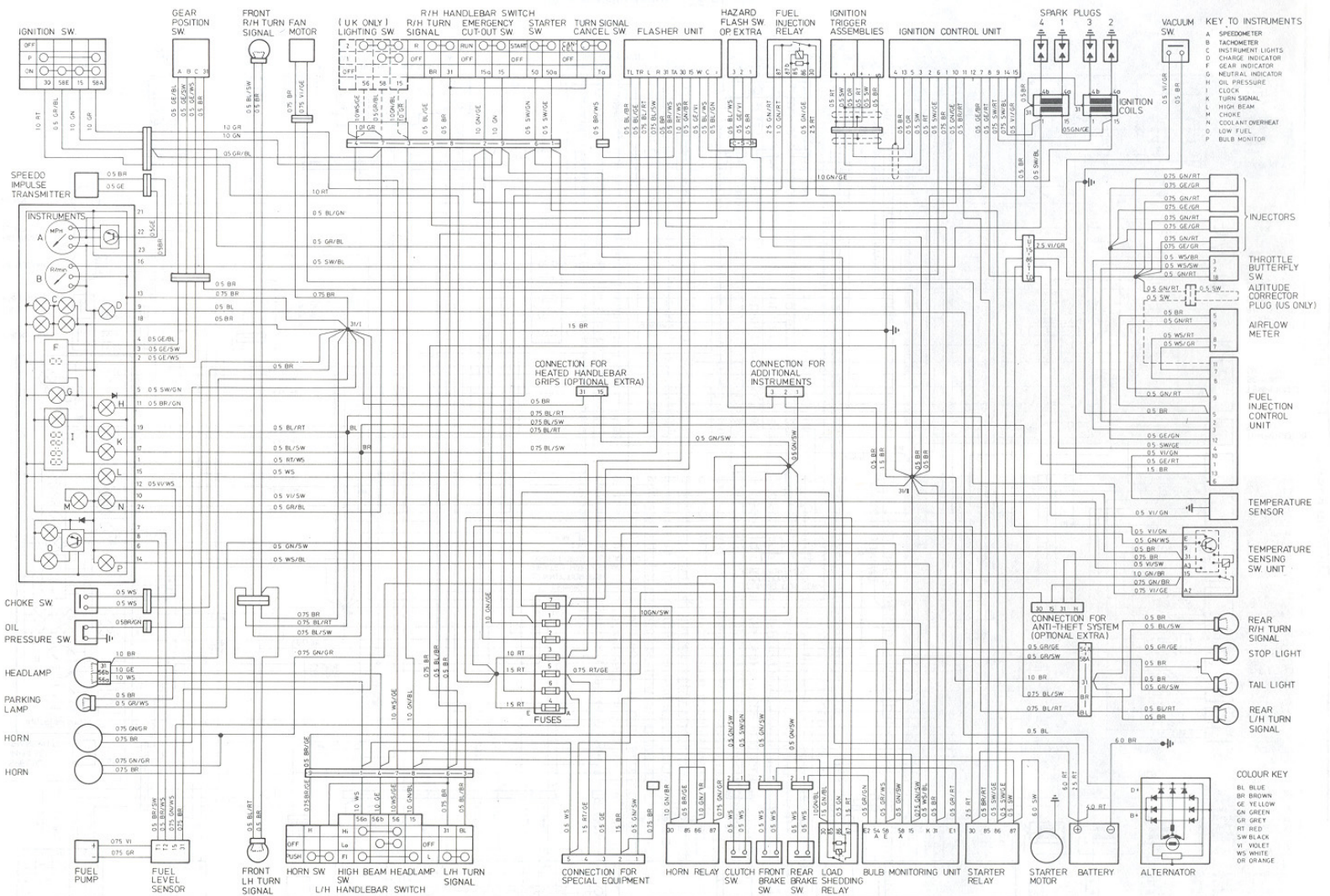

Wiring diagram – early K100 models

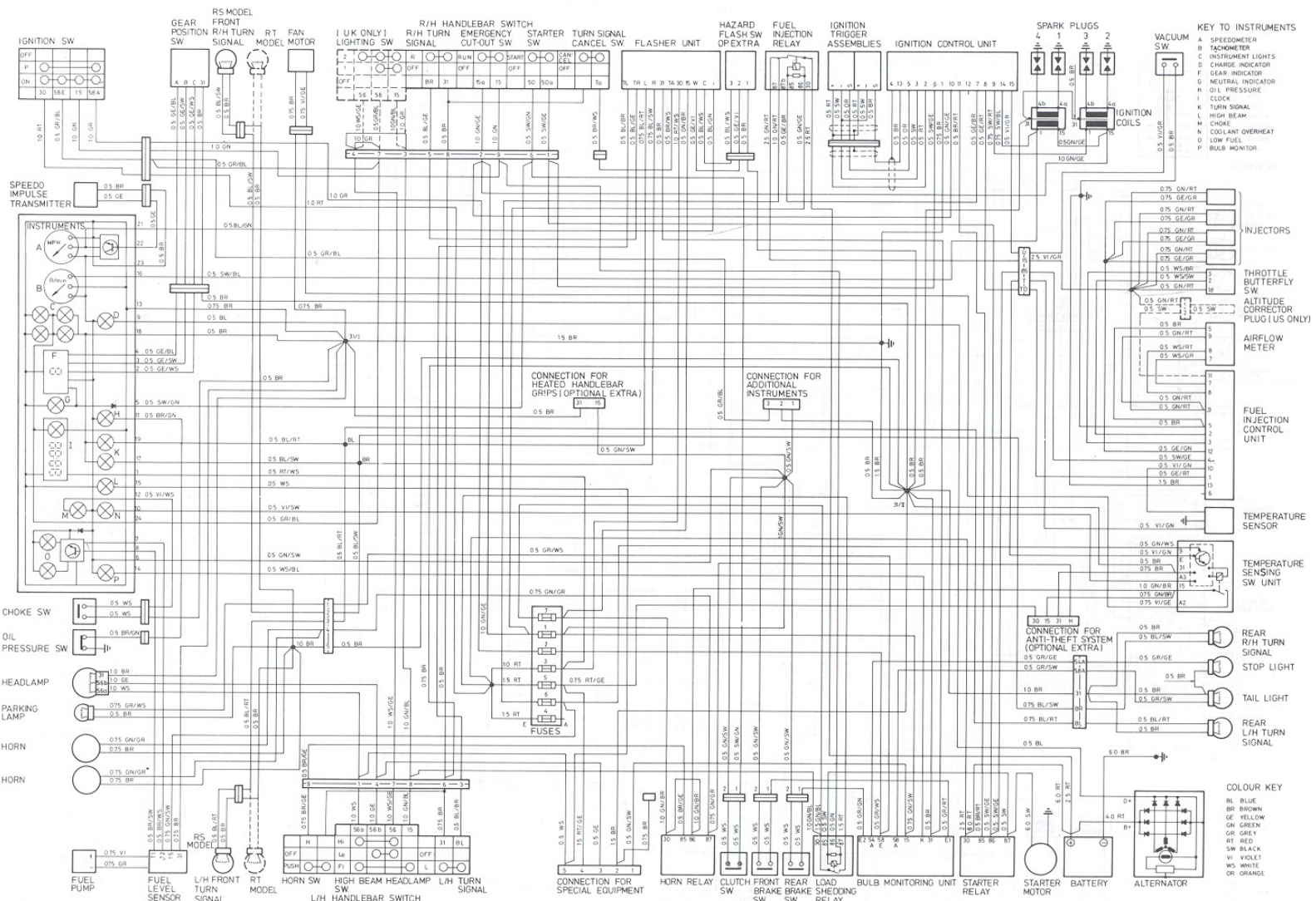

Wiring diagram – early K100 RS and RT models

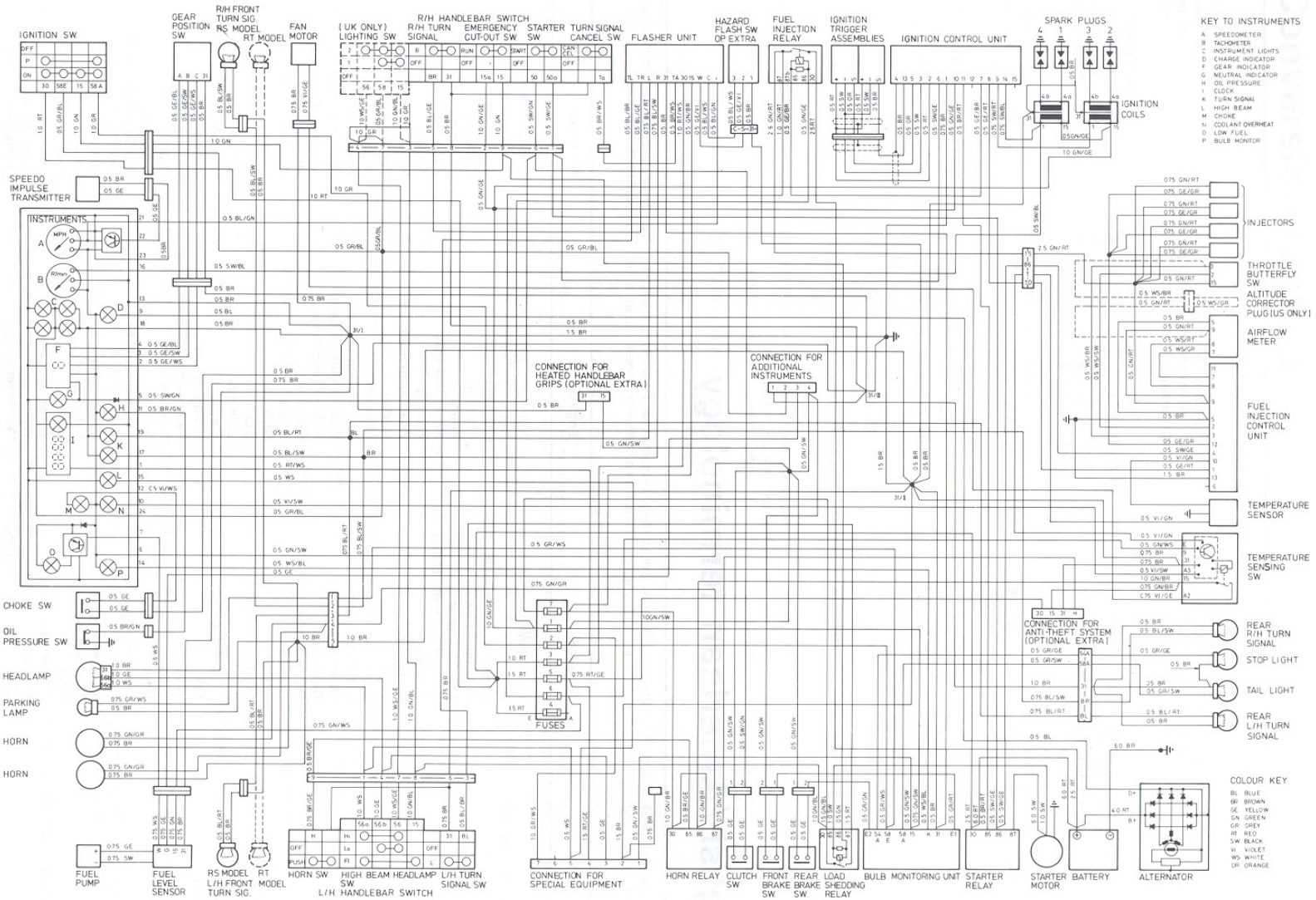

Wiring diagram – late K100 RS and RT models

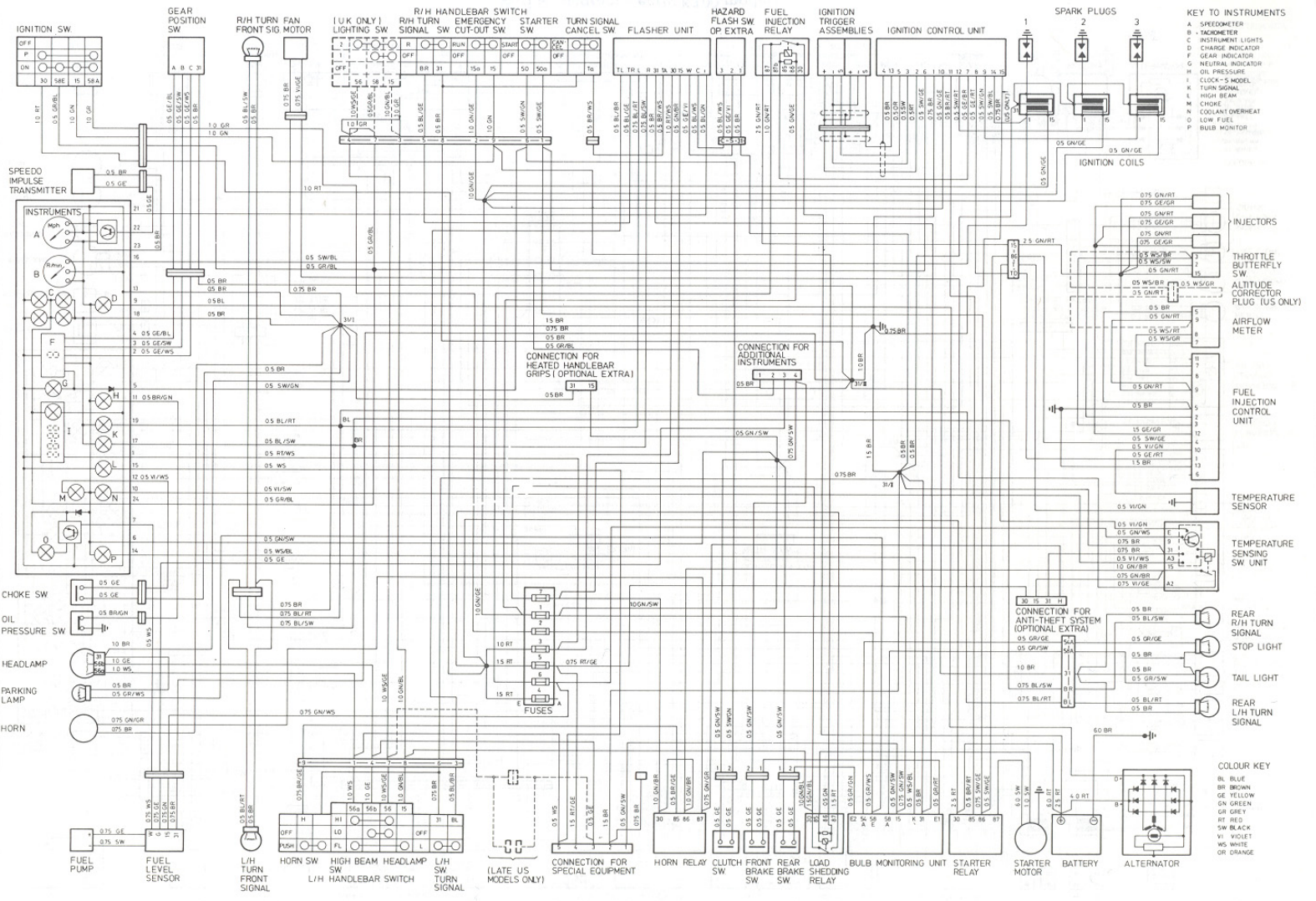

- KEY TO INSTRUMENTS**
- A SPEEDOMETER
 - B TACHOMETER
 - C INSTRUMENT LIGHTS
 - D CHARGE INDICATOR
 - E GEAR INDICATOR
 - F NEUTRAL INDICATOR
 - G OIL PRESSURE
 - H TURN SIGNAL
 - I CLUCK-S MODEL
 - J CHOKE
 - K HIGH BEAM
 - L M COOLANT OVERHEAT
 - O LOW FUEL
 - P BULB MONITOR

- COLOUR KEY**
- BL BLUE
 - BR BROWN
 - GE YELLOW
 - GN GREEN
 - GR GREY
 - RD RED
 - SW BLACK
 - VI VIOLET
 - WS WHITE
 - OR ORANGE

Wiring diagram - 75 models